

Asian Youth Indoor Archery Open (Hong Kong 2016)(Star Shoot)

26-29 Jul 2016

Tin Shui Wai Sports Centre

Result

Recurve (Boy Division) Grade A Qualification Round

Rank	Target No.	Name	Member No.	Team	YOB	Result										
						1st 18M	10	9	2nd 18M	10	9	Total	Total 10	Total 9		
1	1B	Lin Curtis	M4616S	La Salle College (Hong Kong)	1999	275	(1)	12	11	282	(1)	17	9	557	29	20
2	6C	So Chun Ngai Ugo	M4257S	La Salle College (Hong Kong)	1998	269	(3)	11	13	275	(2)	10	16	544	21	29
3	3B	Chan Chun Tim	M5405S	Hong Kong Paralympic Committee & Sports Association for the Physically Disabled (Hong Kong)	1997	266	(4)	9	17	272	(3)	11	11	538	20	28
4	3D	Kwan Chun Ho Eric Jr.	M4750S	Police Archery Club (Hong Kong)	1997	265	(5)	10	11	263	(4)	7	13	528	17	24
5	5C	Leung Tsz Lok	M4260S	La Salle College (Hong Kong)	1998	270	(2)	11	11	246	(9)	6	11	516	17	22
6	6B	Tsang Hui Fai	M5080S	St. Paul's College Archery Club (Hong Kong)	1999	253	(7)	7	11	258	(6)	6	13	511	13	24
7	5D	Tam Ka Wing	M5860S	Shi Hui Wen Secondary School (Hong Kong)	1997	247	(8)	0	14	262	(5)	8	10	509	8	24
8	2D	Wong Ka Lok	M4435S	Police Archery Club (Hong Kong)	1998	262	(6)	12	10	246	(10)	3	15	508	15	25
9	6A	Wong Wai Kit Ricky	M6044S	Hong Kong Institute of Vocational Education (Shatin) (Hong Kong)	1996	232	(14)	6	10	257	(7)	4	19	489	10	29
10	2B	Ho Cheuk Kwan	M4572S	S T F A Tam Pak Yu College (Hong Kong)	1999	233	(12)	3	9	245	(11)	9	10	478	12	19
11	5B	Chin Pak Lam Bevis	Temp	N.L.S.I. Lui Kwok Pat Fong College (Hong Kong)	1999	225	(16)	5	7	249	(8)	5	10	474	10	17
12	3A	Chan Chun Ho	M5886S	Shatin Sports Association Archery Club (Hong Kong)	1998	233	(13)	3	7	241	(12)	4	11	474	7	18
13	4D	Lau Siu Hin, Marcus	M4453	Police Archery Club (Hong Kong)	1998	246	(10)	4	11	224	(16)	4	8	470	8	19
14	4C	Sing Lok	M5788S	Hong Kong Fanling Lutheran Secondary School (Hong Kong)	1999	229	(15)	6	6	240	(13)	5	6	469	11	12
15	4B	Tsui Chun Kit	Temp	N.L.S.I. Lui Kwok Pat Fong College (Hong Kong)	1999	240	(11)	1	10	227	(14)	4	11	467	5	21
16	2C	Wong Cheuk Yin	M6113S	Hong Kong Institute of Vocational Education (Shatin) (Hong Kong)	1997	207	(17)	2	4	223	(17)	2	6	430	4	10
17	4A	Kwan Ho Lun Kevin	M6073S	HKUST (Hong Kong)	1997	246	(9)	5	7	180	(19)	4	3	426	9	10
18	5A	Man Kam Sing	M6107S	Hong Kong Institute of Vocational Education (Shatin) (Hong Kong)	1997	190	(19)	1	6	224	(15)	5	8	414	6	14
19	3C	Li Zhenghao	M4973S	HKMA K. S. Lo College (Hong Kong)	1999	206	(18)	3	7	204	(18)	3	5	410	6	12
20	1D	Kong Chun Lok	M6311S	St. Paul's College Archery Club (Hong Kong)	1998	158	(20)	0	6	99	(21)	0	2	257	0	8
21	1C	Wong Pak Hei Carlos	M6108S	Hong Kong Institute of Vocational Education (Shatin) (Hong Kong)	1996	89	(21)	0	1	122	(20)	0	5	211	0	6
22	2A	Lui Siu Chik	M5365S	North District Archery Club (Hong Kong)	1997	46	(22)	1	1	6	(22)	0	0	52	1	1
ABS	1A	Wan Ho Hin	M4869S	Hong Kong Fanling Lutheran Secondary School Archery Club (Hong Kong)	1998	0	(23)	0	0	0	(23)	0	0	0	0	0

Recurve (Boy Division) Grade B Qualification Round

Rank	Target No.	Name	Member No.	Team	YOB	Result										
						1st 18M	10	9	2nd 18M	10	9	Total	Total 10	Total 9		
1	10B	Yeung Hop To	M5354S	La Salle College Archery Club (Hong Kong)	2000	265	(1)	7	13	269	(2)	9	12	534	16	25
2	11C	Pun Ming Yan	M6184S	HKMA K. S. Lo College (Hong Kong)	2001	263	(2)	5	16	270	(1)	9	13	533	14	29
3	6D	Luo Xi Long	Temp	FuTian Shejian Association	2000	260	(4)	9	12	265	(3)	11	11	525	20	23
4	13A	Shong Dominic	M5867S	HK Youth Archery Squad (Hong Kong)	2001	257	(5)	6	11	266	(3)	8	18	523	14	29
5	12A	Ming Pok Him	M4870S	HK Youth Archery Squad (Hong Kong)	2000	262	(3)	10	11	248	(6)	7	7	510	17	18
6	8C	Cheung Chung Yip	M5048S	STFA Seaward Woo College Archery Club (Hong Kong)	2000	244	(7)	3	11	264	(4)	7	12	508	10	23
7	12C	Wu Shi Yan	M5791S	Hong Kong Fanling Lutheran Secondary School (Hong Kong)	2001	256	(6)	5	12	243	(7)	8	3	499	13	15
8	9C	Lee Nap Tak	M5453S	STFA Seaward Woo College Archery Club (Hong Kong)	2001	253	(7)	7	10	233	(14)	4	9	486	11	19
9	10A	Brandon Kok Kai Chuen	G6294S	Shekou International School	2001	252	(8)	6	11	229	(16)	4	7	481	10	18
10	8B	Wong Hong Yat Conrad	M5325S	La Salle College Archery Club (Hong Kong)	2000	242	(8)	6	10	236	(9)	6	11	478	12	21
11	11A	Cheuk Tsz Yin	M4144S	HK Youth Archery Squad (Hong Kong)	2001	233	(12)	4	10	237	(10)	6	7	470	10	17
12	12B	Cheung Ka Hung	M6012S	Shun Tak Fraternal Association Seaward Woo College (Hong Kong)	2001	231	(13)	6	4	238	(9)	4	6	469	10	10
13	7C	Chan Chi Hung Wesley	Temp	South Island School (Hong Kong)	2001	228	(12)	6	5	236	(10)	6	7	464	12	12
14	8A	Hui Hoi Chung, Jonathan	M3717S	Eastman Archery Club (Hong Kong)	2000	236	(9)	4	7	214	(15)	5	7	450	9	14
15	8D	Cheng Wai Hong	M6172S	S T F A Tam Pak Yu College (Hong Kong)	2001	211	(15)	6	5	234	(11)	6	7	445	12	12
16	7B	Lew Pui Kai	M5326S	La Salle College Archery Club (Hong Kong)	2001	203	(16)	4	7	232	(13)	4	9	435	8	16
17	7D	Wu Chun Ho	M5645S	S T F A Tam Pak Yu College (Hong Kong)	2000	219	(13)	3	11	213	(16)	2	9	432	5	20
18	10D	Ngai Chun Hei Gerald	Temp	St. Paul's College Archery Club (Hong Kong)	2000	216	(16)	5	6	207	(19)	3	3	423	8	9
19	9D	Wong Chon In	M5543S	Ho Yu College and Primary School (Sponsored By Sik Sik Yuen) (Hong Kong)	2001	176	(22)	2	4	241	(8)	7	5	417	9	9
20	9A	Lee Chak Nam	M5946S	Eastman Archery Club (Hong Kong)	2001	179	(20)	3	3	199	(21)	5	7	378	8	10
21	11B	Chung Wing Nam	M5450S	Shun Tak Fraternal Association Seaward Woo College (Hong Kong)	2001	201	(19)	4	4	168	(23)	2	7	369	6	11
22	7A	Zhou Shi Jie	Temp	Shanghai Hongkou Experimental School	2001	151	(21)	0	3	201	(18)	3	5	352	3	8
23	9B	So Chung Hei	M5327S	La Salle College Archery Club (Hong Kong)	2000	179	(21)	1	10	169	(22)	3	5	348	4	15
24	12D	Ngai Sean Gracias	Temp	St. Paul's College Archery Club (Hong Kong)	2000	139	(24)	2	1	161	(24)	3	3	300	5	4
25	13B	Leung Cheuk Kwan	M5452S	Shun Tak Fraternal Association Seaward Woo College (Hong Kong)	2001	130	(25)	1	2	136	(25)	1	5	266	2	7
26	11D	Wong Cheuk Fai Jeffrey	M5686S	St. Paul's College Archery Club (Hong Kong)	2001	119	(26)	0	3	97	(26)	0	1	216	0	4
ABS	10C	Wong Ka Lok	M4971S	HKMA K. S. Lo College (Hong Kong)	2000	0	(27)	0	0	0	(27)	0	0	0	0	0

Asian Youth Indoor Archery Open (Hong Kong 2016)(Star Shoot)

26-29 Jul 2016

Tin Shui Wai Sports Centre

Result

Recurve (Boy Division) Grade C Qualification Round

Rank	Target No.	Name	Member No.	Team	YOB	Result										
						1st 18M	10	9	2nd 18M	10	9	Total	Total 10	Total 9		
1	17D	Ngai Ho Chun	M5765S	St. Paul's College Archery Club (Hong Kong)	2002	267	(1)	9	11	261	(1)	11	5	528	20	16
2	15B	Wu Yi Feng	Temp	FuTian Shejian Association	2002	260	(3)	7	12	259	(3)	10	6	519	17	18
3	14D	Lee Chun Yin Isaac	M5982S	La Salle College Archery Club (Hong Kong)	2002	257	(4)	5	11	260	(2)	7	8	517	12	19
4	17C	Wong Tsz Yiu	M5793S	HK Youth Archery Squad (Hong Kong)	2002	255	(5)	4	11	243	(6)	6	10	498	10	21
5	16B	He Guan Bin	Temp	FuTian Shejian Association	2002	236	(9)	2	10	259	(4)	8	9	495	10	19
6	17A	Chen Yi Hua	Temp	Shanghai Bowsac Archery Club	2003	261	(2)	9	9	231	(9)	4	7	492	13	16
7	14A	Song Guang Zhe	Temp	Shanghai Hongkou Experimental School	2002	246	(7)	6	5	245	(5)	7	6	491	13	11
8	15A	Zhang Wei Li	Temp	Shanghai Hongkou Experimental School	2003	232	(10)	5	7	242	(7)	6	6	474	11	13
9	18A	Chan Wing Ki	M6167S	Hong Kong Fanling Lutheran Secondary School (Hong Kong)	2003	238	(8)	1	13	220	(10)	5	6	458	6	19
10	13D	Lo Yee Chun	M5921S	La Salle College Archery Club (Hong Kong)	2002	212	(12)	3	5	231	(8)	5	8	443	8	13
11	17B	Xu Zhen	Temp	FuTian Shejian Association	2003	247	(6)	6	8	191	(14)	3	4	438	9	12
12	14C	lu Pak Hung	M6165S	Hong Kong Fanling Lutheran Secondary School Archery Club (Hong Kong)	2002	218	(11)	3	7	213	(11)	3	7	431	6	14
13	16A	Ding Yu Su	Temp	Shanghai Hongkou Experimental School	2003	195	(13)	2	6	194	(12)	4	2	389	6	8
14	15C	Wong Ling Yin	Temp	Diocesan Boys' School (Hong Kong)	2003	185	(14)	5	3	193	(13)	6	5	378	11	8
15	13C	Wu Yu Jie	Temp	Shanghai Bowsac Archery Club	2002	155	(15)	1	3	187	(15)	0	7	342	1	10
16	16D	Chan Yick Full Nathan	M6250S	St. Paul's College Archery Club (Hong Kong)	2003	150	(16)	1	3	151	(16)	0	5	301	1	8
17	16C	Bryan Kok Kai Aun	G6293S	Shekou International School	2003	145	(17)	3	3	132	(17)	1	5	277	4	8
18	15D	Lau Chun Wang Justin	Temp	St. Paul's College Archery Club (Hong Kong)	2003	93	(18)	0	4	103	(18)	0	1	196	0	5
ABS	14B	Chan Chun On	M6162S	Hong Kong Fanling Lutheran Secondary School (Hong Kong)	2002	0	(19)	0	0	0	(19)	0	0	0	0	0

Recurve (Boy Division) Grade D Qualification Round

Rank	Target No.	Name	Member No.	Team	YOB	Result										
						1st 18M	10	9	2nd 18M	10	9	Total	Total 10	Total 9		
1	21C	Yu Zhuo Chen	Temp	FuTian Shejian Association	2006	196	(2)	2	7	221	(1)	4	6	417	6	13
2	22B	Wu Jia Liang	Temp	Shanghai Songjiang Sijing Youth Archery Team	2004	204	(1)	2	2	199	(2)	4	5	403	6	7
3	19D	Yang Hao Yu	Temp	Shanghai Songjiang Sijing Youth Archery Team	2005	176	(4)	3	2	149	(4)	1	4	325	4	6
4	18B	So Ho Ming	M6302S	Golden Trust Archery Club (Hong Kong)	2005	177	(3)	0	3	145	(6)	2	6	322	2	9
5	18C	Lou Qi Hao	Temp	Shanghai Songjiang Sijing Youth Archery Team	2004	160	(5)	2	1	148	(5)	1	1	308	3	2
6	20D	Ma Zhen Yan	Temp	Shanghai Songjiang Sijing Youth Archery Team	2005	126	(7)	0	2	169	(3)	2	1	295	2	3
7	20A	Cheung Sun Hin Moses	Temp	North District Archery Club (Hong Kong)	2004	130	(6)	3	4	143	(7)	0	3	273	3	7
8	20B	Wong Chun Yee	M4633S	The Scout Association of Hong Kong (Hong Kong)	2005	124	(8)	3	2	120	(8)	0	2	244	3	4
9	22C	Mok Wing Hei Valeno	M4728S	The Scout Association of Hong Kong (Hong Kong)	2004	120	(10)	0	1	90	(12)	0	2	210	0	3
10	18D	Wong Kin Hin	M5821S	The Scout Association of Hong Kong (Hong Kong)	2004	104	(12)	2	0	96	(10)	2	1	200	4	1
11	19A	Abdullah Al-Mashhdani	Temp	Iraqi Archery Federation	2006	120	(9)	1	2	70	(14)	1	1	190	2	3
12	22A	Sugiyama Tomoki	G6295S	Shekou International School	2004	88	(13)	0	2	94	(11)	1	2	182	1	4
13	21A	Leung Kwan Ki	M6056S	North District Archery Club (Hong Kong)	2004	69	(16)	1	0	98	(9)	2	1	167	3	1
14	21B	Cheung Shan Zhi Ian	Temp	Police Archery Club (Hong Kong)	2004	113	(11)	2	5	40	(16)	0	0	153	2	5
15	22D	Hou Jin	Temp	Shanghai Songjiang Sijing Youth Archery Team	2005	60	(17)	0	1	78	(13)	1	4	138	1	5
16	21D	Deng Zi Xuan	Temp	Shanghai Songjiang Sijing Youth Archery Team	2005	80	(14)	0	0	44	(15)	0	1	124	0	1
17	19B	Leung Pok Yeung	M5810S	The Scout Association of Hong Kong (Hong Kong)	2007	76	(15)	1	2	24	(17)	1	0	100	2	2
18	20C	Tse Hok Sung	M6299S	Golden Trust Archery Club (Hong Kong)	2005	41	(18)	0	0	20	(18)	0	0	61	0	0
19	19C	So Ho Wai	M6301S	Golden Trust Archery Club (Hong Kong)	2008	15	(19)	0	0	0	(19)	0	0	15	0	0

Asian Youth Indoor Archery Open (Hong Kong 2016)(Star Shoot)
26-29 Jul 2016
Tin Shui Wai Sports Centre
Result

Recurve (Girl Division) Grade A Qualification Round

Rank	Target No.	Name	Member No.	Team	YOB	Result										
						1st 18M	10	9	2nd 18M	10	9	Total	Total 10	Total 9		
1	4A	Lee Shuk Kwan	M4381S	HKUST (Hong Kong)	1997	271	(1)	13	13	271	(1)	8	15	542	21	28
2	3B	Ho Ching Yan	M5534S	Pui Ching Middle School (Hong Kong)	1999	260	(3)	6	11	268	(2)	9	10	528	15	21
3	4C	Chu Man Ching	M4438S	True Light Archery Club (Hong Kong)	1997	261	(2)	6	13	255	(7)	5	14	516	11	27
4	5B	Chin Pui Yu	M6181S	Christian Zheng Sheng College (Hong Kong)	1998	251	(6)	8	10	262	(3)	9	12	513	17	22
5	1C	Chan Tsz Ning	M4683S	Hong Kong True Light College (Hong Kong)	1999	251	(7)	7	11	261	(4)	8	12	512	15	23
6	1B	Poon Wei Tsing Natalie	M5533S	Pui Ching Middle School (Hong Kong)	1999	252	(5)	6	8	257	(5)	7	11	509	13	19
7	3C	Wang Cheuk Ying	M4355S	True Light Archery Club (Hong Kong)	1998	253	(4)	4	16	249	(9)	10	9	502	14	25
8	2D	Wong Lok Yi	M5719S	Christian Zheng Sheng College (Hong Kong)	1999	242	(10)	5	8	256	(6)	4	15	498	9	23
9	2B	Tsang Miu Hin	M5536S	Pui Ching Middle School (Hong Kong)	1999	251	(8)	4	13	245	(10)	4	9	496	8	22
10	3A	Chan Bertina Wing Heng	M3757S	Eastman Archery Club (Hong Kong)	1996	241	(11)	6	9	253	(8)	5	15	494	11	24
11	4B	Leung Nga Nam	M6182S	Christian Zheng Sheng College (Hong Kong)	1998	250	(9)	6	7	244	(11)	2	11	494	8	18
12	5C	Chan Hoi Man	M4678S	True Light Archery Club (Hong Kong)	1997	239	(12)	6	9	223	(12)	3	9	462	9	18
13	1A	Lin Yi Kei	M4011S	Hong Kong Fanling Lutheran Secondary School Archery Club (Hong Kong)	1997	235	(13)	8	9	215	(13)	1	9	450	9	18
14	1D	Lai Man Ting	M6284S	Christian Zheng Sheng College (Hong Kong)	1996	227	(14)	4	5	201	(16)	5	6	428	9	11
15	6A	OU LY	M5421S	STFA Seaward Woo College Archery Club (Hong Kong)	1999	205	(15)	2	3	214	(14)	5	8	419	7	11
16	2A	Mok Tsz Chin	M3545S	North District Archery Club (Hong Kong)	1998	196	(16)	2	6	207	(15)	2	9	403	4	15
17	5A	Lam Lok Yee Ada	M6206S	HKUST (Hong Kong)	1996	189	(17)	5	3	161	(17)	1	2	350	6	5
18	4D	Cheung Tin Yuet	M4522S	Hong Kong Fanling Lutheran Secondary School (Hong Kong)	1999	122	(18)	1	4	145	(18)	0	7	267	1	11
ABS	2C	Chung Ching In	M4681S	Hong Kong True Light College (Hong Kong)	1999	0	(19)	0	0	0	(19)	0	0	0	0	0
ABS	3D	Cheung Wing Sze	Temp	Christian Zheng Sheng College (Hong Kong)	1998	0	(19)	0	0	0	(19)	0	0	0	0	0
ABS	5D	Wong Ting	Temp	N.L.S.I. Lui Kwok Pat Fong College (Hong Kong)	1999	0	(19)	0	0	0	(19)	0	0	0	0	0

Recurve (Girl Division) Grade B Qualification Round

Hong Kong Junior Record (Age 15-16)

Rank	Target No.	Name	Member No.	Team	YOB	Result										
						1st 18M	10	9	2nd 18M	10	9	Total	Total 10	Total 9		
1	8C	Chu Ho Lam Clara	M5381S	True Light Archery Club (Hong Kong)	2001	250	(2)	8	10	279	(1)	13	14	529	21	24
2	6C	Choy Siu Ying Zoe	M5418S	HK Youth Archery Squad (Hong Kong)	2001	255	(1)	6	10	254	(4)	6	14	509	12	24
3	8B	Ho Cheuk Lam Kelly	M5424S	Hong Kong Fanling Lutheran Secondary School (Hong Kong)	2001	244	(3)	4	11	260	(2)	9	8	504	13	19
4	8A	Lam Wing Yee	M5417S	HK Youth Archery Squad (Hong Kong)	2001	236	(5)	6	8	255	(3)	3	12	491	9	20
5	7C	Lau Seen Yu	M5734S	Hong Kong True Light College (Hong Kong)	2001	233	(7)	3	8	238	(6)	4	10	471	7	18
6	6B	Li Sin Ling	M5397S	True Light Archery Club (Hong Kong)	2001	243	(4)	2	9	216	(8)	1	5	459	3	14
7	7A	Lui Min Xi	M6092S	The Chinese Foundation Secondary School (Hong Kong)	2000	233	(6)	5	7	220	(7)	3	7	453	8	14
8	6D	Chan Wing Yan	M5448S	Shun Tak Fraternal Association Seaward Woo College (Hong Kong)	2001	206	(9)	2	8	246	(5)	7	8	452	9	16
9	7D	Tsang Hei Man	M5049S	Shun Tak Fraternal Association Seaward Woo College (Hong Kong)	2000	230	(8)	4	7	202	(9)	4	5	432	8	12
10	7B	Cheung Sum Yu	M6257S	Christian Zheng Sheng College (Hong Kong)	2000	165	(10)	2	7	173	(10)	1	6	338	3	13

Asian Youth Indoor Archery Open (Hong Kong 2016)(Star Shoot)

26-29 Jul 2016

Tin Shui Wai Sports Centre

Result

Recurve (Girl Division) Grade C Qualification Round

Rank	Target No.	Name	Member No.	Team	YOB	Result										
						1st 18M	10	9	2nd 18M	10	9	Total	Total 10	Total 9		
1	15D	Pang Lok Man	M4946S	Police Archery Club (Hong Kong)	2002	264	(2)	6	15	259	(0)	7	16	523	13	31
2	15C	Leung Lok Yiu	M5735S	Hong Kong True Light College (Hong Kong)	2002	264	(1)	10	9	251	(0)	7	9	515	17	18
3	11A	Zhang Si Yang	Temp	Shanghai Hongkou Experimental School	2003	246	(3)	3	8	249	(2)	7	8	495	10	16
4	12A	Jiang Ding Wen	Temp	Shanghai Bowsac Archery Club	2002	230	(6)	4	11	256	(1)	5	11	486	9	22
5	10D	Yim Tsz Ching	M5787S	Hong Kong Fanling Lutheran Secondary School (Hong Kong)	2002	233	(4)	6	6	223	(6)	6	5	456	12	11
6	13D	Fung Chin Wing	M5576S	Police Archery Club (Hong Kong)	2002	225	(8)	2	6	231	(3)	8	4	456	10	10
7	11D	Zheng Yi Man	Temp	FuTian Shejian Association	2002	221	(9)	8	2	231	(4)	3	10	452	11	12
8	10A	Ding Er Ni	Temp	Shanghai Hongkou Experimental School	2003	232	(5)	6	6	206	(8)	4	4	438	10	10
9	11C	Han Lillian	G6297S	Shekou International School	2003	219	(10)	3	6	189	(10)	2	6	408	5	12
10	14D	Cheung Tsz Lok Rachel	M5961S	Police Archery Club (Hong Kong)	2003	227	(7)	4	6	180	(0)	2	7	407	6	13
11	13A	Chan Yuk Kie	M6111S	The Chinese Foundation Secondary School (Hong Kong)	2002	178	(16)	2	6	228	(5)	4	11	406	6	17
12	14C	Poon Yuk Hei	M5902S	STFA Seaward Woo College Archery Club (Hong Kong)	2002	167	(19)	1	8	231	(0)	6	6	398	7	14
13	9D	Lee Wing Lam	M5969S	True Light Archery Club (Hong Kong)	2003	211	(11)	3	7	161	(14)	2	3	372	5	10
14	13B	Ho Tzi Ying	M6201S	HKMA K. S. Lo College (Hong Kong)	2002	178	(17)	1	8	192	(9)	1	5	370	2	13
15	9B	Chan Yin Tsun	M5967S	Hong Kong True Light College (Hong Kong)	2002	184	(14)	2	5	184	(11)	3	4	368	5	9
16	15B	Leung Dik Wun Miedi	M6000S	True Light Archery Club (Hong Kong)	2002	183	(15)	2	2	176	(0)	4	1	359	6	3
17	14A	Choi Pui Ying Therese	M6163S	Hong Kong Fanling Lutheran Secondary School Archery Club (Hong Kong)	2003	191	(12)	3	3	160	(0)	3	5	351	6	8
18	13C	Leung Ka Wan	Temp	South Island School (Hong Kong)	2003	170	(18)	1	4	175	(12)	1	2	345	2	6
19	11B	Tam Wan Ching Tiffany	M6200S	HKMA K. S. Lo College (Hong Kong)	2002	133	(25)	1	3	208	(7)	3	6	341	4	9
20	9A	Zhang Xi An	Temp	Shanghai Hongkou Experimental School	2002	161	(20)	2	4	161	(15)	1	3	322	3	7
21	12D	Fung Pui Wing	M6090S	Good Hope School (Hong Kong)	2002	144	(24)	1	4	174	(13)	1	6	318	2	10
22	15A	Hui Eliss Havilah	M5809S	North District Archery Club (Hong Kong)	2003	156	(22)	3	3	159	(0)	1	6	315	4	9
23	9C	Lau Cheuk Ying	M5986S	North District Archery Club (Hong Kong)	2003	152	(23)	2	2	143	(16)	1	4	295	3	6
24	12C	Dai Jin	G6300S	Golden Trust Archery Club (China)	2003	157	(21)	3	3	135	(17)	3	2	292	6	5
25	10C	Xue Emmie	G6291S	Shekou International School	2003	188	(13)	3	5	98	(18)	1	1	286	4	6
26	14B	Chan Wing Lam	M6175S	True Light Archery Club (Hong Kong)	2002	87	(26)	0	3	90	(0)	0	2	177	0	5
27	10B	Lau Sin Yi	M5968S	Hong Kong True Light College (Hong Kong)	2003	75	(27)	1	0	85	(19)	0	2	160	1	2
ABS	12B	Chan Yui Yan	M6195S	HKMA K. S. Lo College (Hong Kong)	2002	0	(28)	0	0	0	(20)	0	0	0	0	0

Recurve (Girl Division) Grade D Qualification Round

Rank	Target No.	Name	Member No.	Team	YOB	Result										
						1st 18M	10	9	2nd 18M	10	9	Total	Total 10	Total 9		
1	16D	Tang Yi	Temp	FuTian Shejian Association	2005	188	(2)	2	7	186	(1)	0	3	374	2	10
2	17A	Li Jia Rong	Temp	Shanghai Hongkou Experimental School	2004	156	(3)	1	8	161	(2)	3	6	317	4	14
3	16A	Luo Zhi Qi	Temp	Shanghai Hongkou Experimental School	2004	190	(1)	2	7	112	(3)	1	2	302	3	9
4	17D	Duan Chen Xi	Temp	FuTian Shejian Association	2005	138	(4)	1	2	103	(4)	1	1	241	2	3
5	17B	Li Xin Rong	Temp	FuTian Shejian Association	2004	123	(5)	4	2	100	(5)	0	0	223	4	2
6	16B	Wen Hao Ting	M6298S	Golden Trust Archery Club (Hong Kong)	2006	97	(6)	0	2	59	(6)	0	2	156	0	4

Asian Youth Indoor Archery Open (Hong Kong 2016)(Star Shoot)
26-29 Jul 2016
Tin Shui Wai Sports Centre
Result

Compound (Boy Division) Grade A Qualification Round

Rank	Target No.	Name	Member No.	Team	YOB	Result										
						1st 18M	10	9	2nd 18M	10	9	Total	Total 10	Total 9		
1	4C	Chan Sze Chai	M4470S	Diocesan Boys' School (Hong Kong)	1996	284	(1)	14	16	281	(2)	12	17	565	26	33
2	2A	Li Jia Wei	Temp	Changzhou Elite Archery Sport Club	1997	281	(2)	11	19	278	(3)	13	14	559	24	33
3	1D	Yu Yat Chun Eugene	M4621S	La Salle College Archery Club (Hong Kong)	1999	277	(3)	11	15	282	(1)	13	16	559	24	31
4	4A	Chan Wai Yin	M4478S	(Hong Kong) Tai Po 08 Archery Club (Hong Kong)	1999	275	(5)	8	20	278	(4)	12	16	553	20	36
5	3B	Luk Kwok Hang	M5050S	STFA Seaward Woo College Archery Club (Hong Kong)	1998	274	(7)	5	24	278	(5)	10	18	552	15	42
6	5B	Chan Conroy Leung Heng	M4418S	La Salle College Archery Club (Hong Kong)	1999	275	(5)	8	20	273	(8)	7	20	548	15	40
7	1C	Wan Cheuk Hei	M4548S	North District Archery Club (Hong Kong)	1997	272	(10)	6	21	273	(6)	8	17	545	14	38
8	3C	Woo Ian Cheuk Yin	M6267S	Diocesan Boys' School (Hong Kong)	1998	276	(4)	9	18	268	(12)	4	20	544	13	38
9	1A	Guan Jian	Temp	Changzhou Elite Archery Sport Club	1996	273	(8)	6	21	269	(11)	4	21	542	10	42
10	3D	Leung Tim Lok Timothy	M4324S	Shau Kei Wan Government Secondary School (Hong Kong)	1997	265	(13)	4	18	273	(6)	8	17	538	12	35
11	4B	Lai Chun Kit	M4619S	La Salle College Archery Club (Hong Kong)	1998	268	(11)	7	16	269	(10)	6	17	537	13	33
12	2B	Lau Ka Kwan	M4197S	STFA Seaward Woo College Archery Club (Hong Kong)	1997	272	(9)	8	17	265	(14)	3	22	537	11	39
13	3A	Tang Ho Man	M3589S	Kowloon Archery Club (Hong Kong)	1997	265	(12)	9	15	271	(9)	7	18	536	16	33
14	5A	Wang Yu Bo	Temp	Beijing National Day School	1999	260	(16)	5	16	262	(15)	5	16	522	10	32
15	2C	Yu Cho Ming, Jeremy	M4472S	Diocesan Boys' School (Hong Kong)	1998	257	(17)	4	19	265	(13)	5	17	522	9	36
16	1B	Cheung Kwai Cheung	M4877S	HK Youth Archery Squad (Hong Kong)	1998	262	(15)	3	17	258	(16)	6	16	520	9	33
17	2D	Lee Tsz Fung	M4325S	Shau Kei Wan Government Secondary School (Hong Kong)	1997	262	(14)	4	24	251	(17)	8	14	513	12	38
18	4D	Chu Chun Yat	M4293S	St. Paul's College Archery Club (Hong Kong)	1998	221	(18)	1	16	133	(18)	4	5	354	5	21

Compound (Boy Division) Grade B Qualification Round

Rank	Target No.	Name	Member No.	Team	YOB	Result										
						1st 18M	10	9	2nd 18M	10	9	Total	Total 10	Total 9		
1	6B	He Jun Hai	Temp	FuTian Shejian Association	2000	274	(1)	7	20	276	(1)	8	20	550	15	40
2	6A	Chong Ho Long	M5891S	HKMA K. S. Lo College (Hong Kong)	2000	253	(3)	5	14	265	(2)	4	18	518	9	32
3	6D	Li Hoi Him	M5413S	St. Paul's College Archery Club (Hong Kong)	2001	255	(2)	5	12	246	(3)	1	13	501	6	25
4	6C	Chan Chun Hei	M5468S	Hong Kong Fanling Lutheran Secondary School (Hong Kong)	2001	249	(4)	1	14	242	(5)	2	15	491	3	29
5	7A	Tang Cheuk Hang	M5581S	HKMA K. S. Lo College (Hong Kong)	2000	236	(6)	0	13	243	(4)	2	13	479	2	26
6	5C	Lee Ka Shun	M5597S	HKMA K. S. Lo College (Hong Kong)	2001	245	(5)	1	15	218	(6)	0	12	463	1	27
7	5D	Li Cheng Lin	Temp	FuTian Shejian Association	2001	163	(7)	1	5	183	(7)	2	7	346	3	12

Asian Youth Indoor Archery Open (Hong Kong 2016)(Star Shoot)
26-29 Jul 2016
Tin Shui Wai Sports Centre
Result

Compound (Boy Division) Grade C Qualification Round

Rank	Target No.	Name	Member No.	Team	YOB	Result										
						1st 18M		10	9	2nd 18M		10	9	Total	Total 10	Total 9
1	7C	Wong Ka Ching	M5910S	St. Paul's College Archery Club (Hong Kong)	2002	271	(1)	4	24	275	(1)	8	19	546	12	43
2	8B	Tsui Chun Kei	M3548S	Police Archery Club (Hong Kong)	2002	248	(2)	3	16	244	(3)	2	19	492	5	35
3	7B	Kwok David	M6168S	Hong Kong Fanling Lutheran Secondary School (Hong Kong)	2003	219	(4)	1	10	247	(2)	1	14	466	2	24
4	7D	Fang Ming Yuan	Temp	FuTian Shejian Association	2002	217	(5)	2	6	199	(5)	1	11	416	3	17
5	8C	Wang Jun Xiang	Temp	FuTian Shejian Association	2004	231	(3)	3	10	182	(6)	0	5	413	3	15
6	8A	Peng Kwan Ho	M6159S	Hong Kong Fanling Lutheran Secondary School (Hong Kong)	2002	211	(6)	1	11	200	(4)	1	7	411	2	18

Compound (Boy Division) Grade D Qualification Round

Rank	Target No.	Name	Member No.	Team	YOB	Result										
						1st 18M		10	9	2nd 18M		10	9	Total	Total 10	Total 9
1	10C	Yang Zi Xuan	Temp	FuTian Shejian Association	2004	265	(1)	4	20	263	(2)	3	19	528	7	39
2	9A	Song Yun	Temp	FuTian Shejian Association	2006	262	(2)	5	14	265	(1)	6	15	527	11	29
3	10D	Li Zong Xi	Temp	FuTian Shejian Association	2005	205	(3)	1	12	242	(3)	6	8	447	7	20
4	9B	Huang Jun Yi	Temp	FuTian Shejian Association	2007	192	(4)	0	8	211	(4)	1	7	403	1	15
5	9C	Zhang Xi He	Temp	FuTian Shejian Association	2006	179	(5)	0	8	191	(5)	1	5	370	1	13
6	11B	Song Yu Tai	Temp	FuTian Shejian Association	2007	181	(1)	2	7	164	(1)	0	7	345	2	14
7	11C	Zheng Su Tong	Temp	Liuzhou Archery Club	2007	141	(2)	0	2	162	(2)	0	7	303	0	9
8	11A	Wu Si Long	Temp	FuTian Shejian Association	2006	129	(3)	0	4	133	(3)	0	4	262	0	8
9	10B	Wei De Long	Temp	FuTian Shejian Association	2006	110	(7)	0	1	141	(6)	0	2	251	0	3
10	10A	Lin Yi Nuo	Temp	FuTian Shejian Association	2007	131	(6)	0	2	106	(7)	0	2	237	0	4
11	9D	Fang Sheng Chuang	Temp	FuTian Shejian Association	2006	98	(8)	0	3	58	(8)	0	1	156	0	4

Asian Youth Indoor Archery Open (Hong Kong 2016)(Star Shoot)
26-29 Jul 2016
Tin Shui Wai Sports Centre
Result

Compound (Girl Division) Grade A Qualification Round

Hong Kong Junior Record (Age 19-20)

Hong Kong Junior Record

Rank	Target No.	Name	Member No.	Team	YOB	Result										
						1st 18M	10	9	2nd 18M	10	9	Total	Total 10	Total 9		
1	12B	Lam Claudia Wing Tung	M4012S	Hong Kong Fanling Lutheran Secondary School Archery Club (Hong Kong)	1997	284	(1)	14	16	285	(1)	16	13	569	30	29
2	12D	Fatimah Al-Mashhdani	Temp	Iraqi Archery Federation	1998	266	(2)	6	22	276	(2)	9	18	542	15	40
3	13A	Tang Lee Ka	M4114S	True Light Archery Club (Hong Kong)	1997	258	(4)	3	21	267	(4)	8	13	525	11	34
4	13B	Lau Tsz Sum	M4700S	Kwok Tak Seng Catholic Secondary School (Hong Kong)	1998	252	(5)	5	18	272	(3)	6	20	524	11	38
5	12A	Mui Wing Tung	M4685S	True Light Archery Club (Hong Kong)	1997	263	(3)	3	18	251	(5)	5	13	514	8	31

Compound (Girl Division) Grade B Qualification Round

Hong Kong Junior Record (Age 15-16)

Hong Kong Cadet Record

Rank	Target No.	Name	Member No.	Team	YOB	Result										
						1st 18M	10	9	2nd 18M	10	9	Total	Total 10	Total 9		
1	14D	Lau Tsz Ching	M4701S	Lock Tao Secondary School (Hong Kong)	2000	283	(1)	13	17	281	(1)	12	17	564	25	34
2	14B	Leung Wing Sum	M5757S	True Light Archery Club (Hong Kong)	2001	270	(3)	6	19	271	(2)	6	19	541	12	38
3	15A	Fung Yee Lok	M5451S	STFA Seaward Woo College Archery Club (Hong Kong)	2001	273	(2)	7	20	265	(3)	7	20	538	14	40
4	15B	Li Ka Yan	M5425S	Hong Kong Fanling Lutheran Secondary School (Hong Kong)	2001	254	(6)	2	14	265	(4)	4	19	519	6	33
5	14A	Chong Wing Wa	M5447S	STFA Seaward Woo College Archery Club (Hong Kong)	2001	259	(4)	3	15	248	(5)	2	15	507	5	30
6	13C	Leung Ching Lam	M5733S	HK Youth Archery Squad (Hong Kong)	2001	252	(7)	5	14	246	(6)	5	10	498	10	24
7	13D	Siu Wing Sang	M6004S	HKMA K. S. Lo College (Hong Kong)	2000	254	(5)	5	11	232	(7)	1	17	486	6	28
8	14C	Yu Shuyi	M6052S	Hong Kong True Light College (Hong Kong)	2000	240	(8)	0	14	204	(9)	1	7	444	1	21
9	15C	Lau Hoi Ching	M6048S	Hong Kong True Light College (Hong Kong)	2001	226	(9)	0	17	205	(8)	2	7	431	2	24

Compound (Girl Division) Grade C Qualification Round

Rank	Target No.	Name	Member No.	Team	YOB	Result										
						1st 18M	10	9	2nd 18M	10	9	Total	Total 10	Total 9		
1	16B	Tung Ka Wai	M5745S	HKBUAS Wong Kam Fai Secondary and Primary School (Hong Kong)	2003	272	(1)	6	20	273	(1)	7	19	545	13	39
2	16A	Hui Ching Nam Crystal	M5764S	HK Youth Archery Squad (Hong Kong)	2002	265	(3)	4	17	256	(2)	4	20	521	8	37
3	16D	Zhang Rui Yu	Temp	FuTian Shejian Association	2002	265	(2)	4	18	245	(4)	1	13	510	5	31
4	16C	Lee Suet Wing	M6050S	Hong Kong True Light College (Hong Kong)	2002	250	(4)	2	13	250	(3)	5	14	500	7	27

Compound (Girl Division) Grade A Elimination Round

Target No. 1/4 1/2 Finals

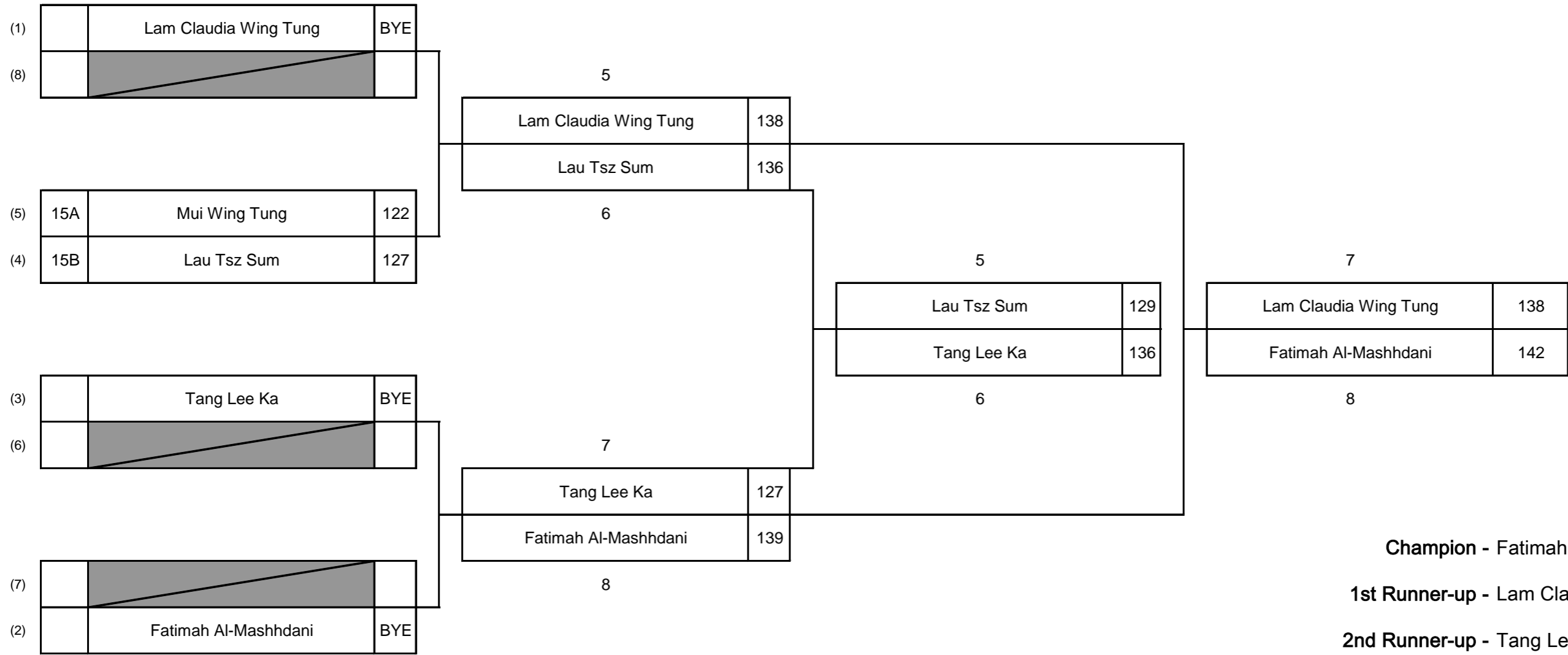

- Champion - Fatimah Al-Mashhdani**
- 1st Runner-up - Lam Claudia Wing Tung**
- 2nd Runner-up - Tang Lee Ka**
- 3rd Runner-up - Lau Tsz Sum**

Compound (Girl Division) Grade B Elimination Round

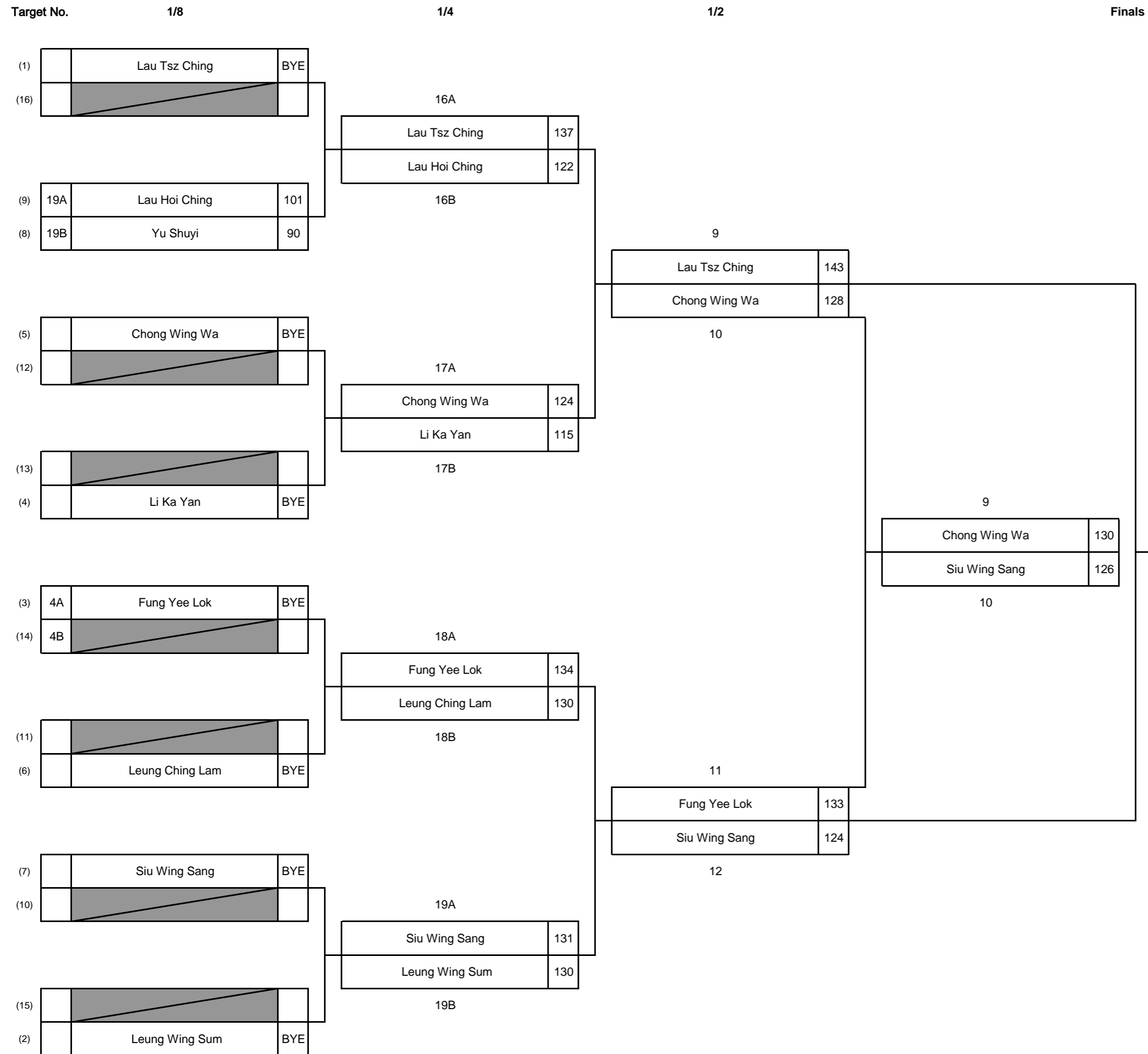

Champion - Lau Tsz Ching
1st Runner-up - Fung Yee Lok
2nd Runner-up - Chong Wing Wa
3rd Runner-up - Siu Wing Sang

Compound (Girl Division) Grade C Elimination Round

Target No.

1/2

Finals

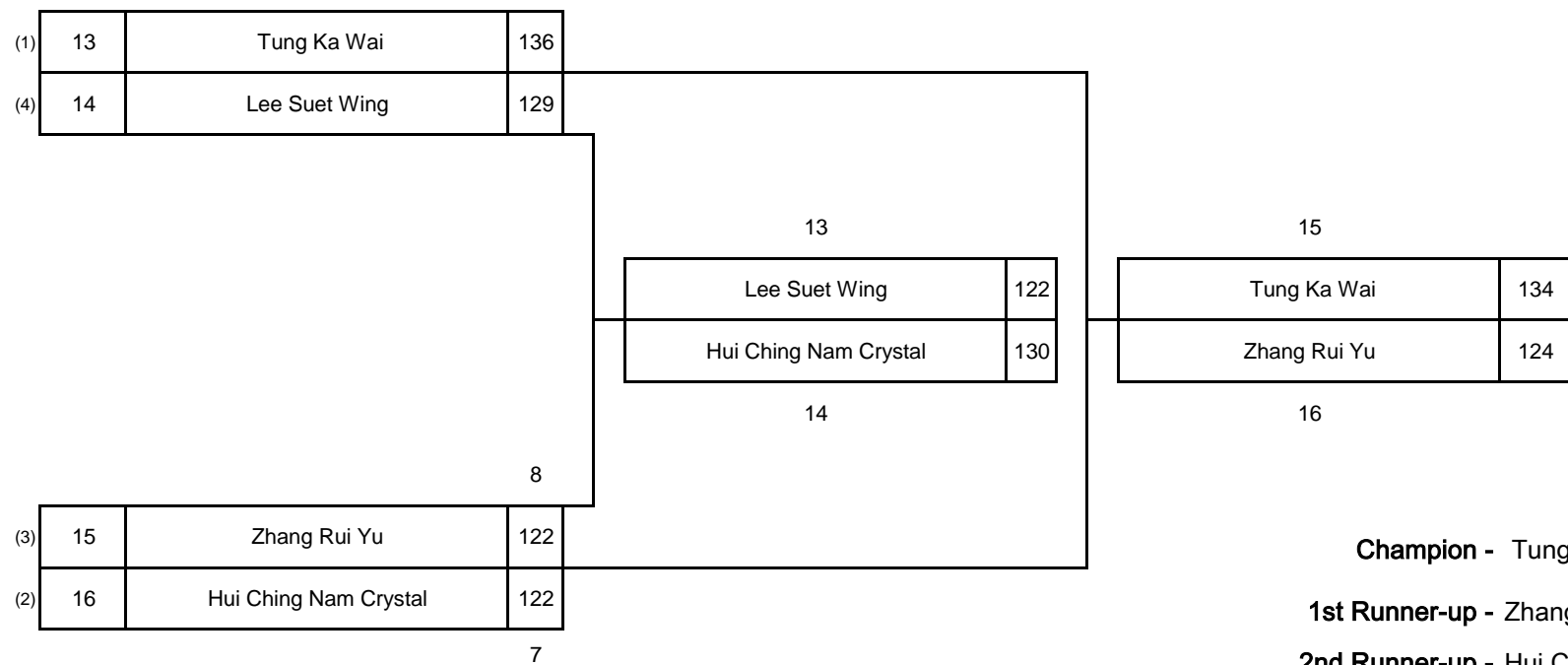

Champion - Tung Ka Wai

1st Runner-up - Zhang Rui Yu

2nd Runner-up - Hui Ching Nam Crystal

3rd Runner-up - Lee Suet Wing

Recurve (Boy Division) Grade A Elimination Round

* Won by shoot-off

Target No. 1/16 1/8 1/4 1/2 Finals

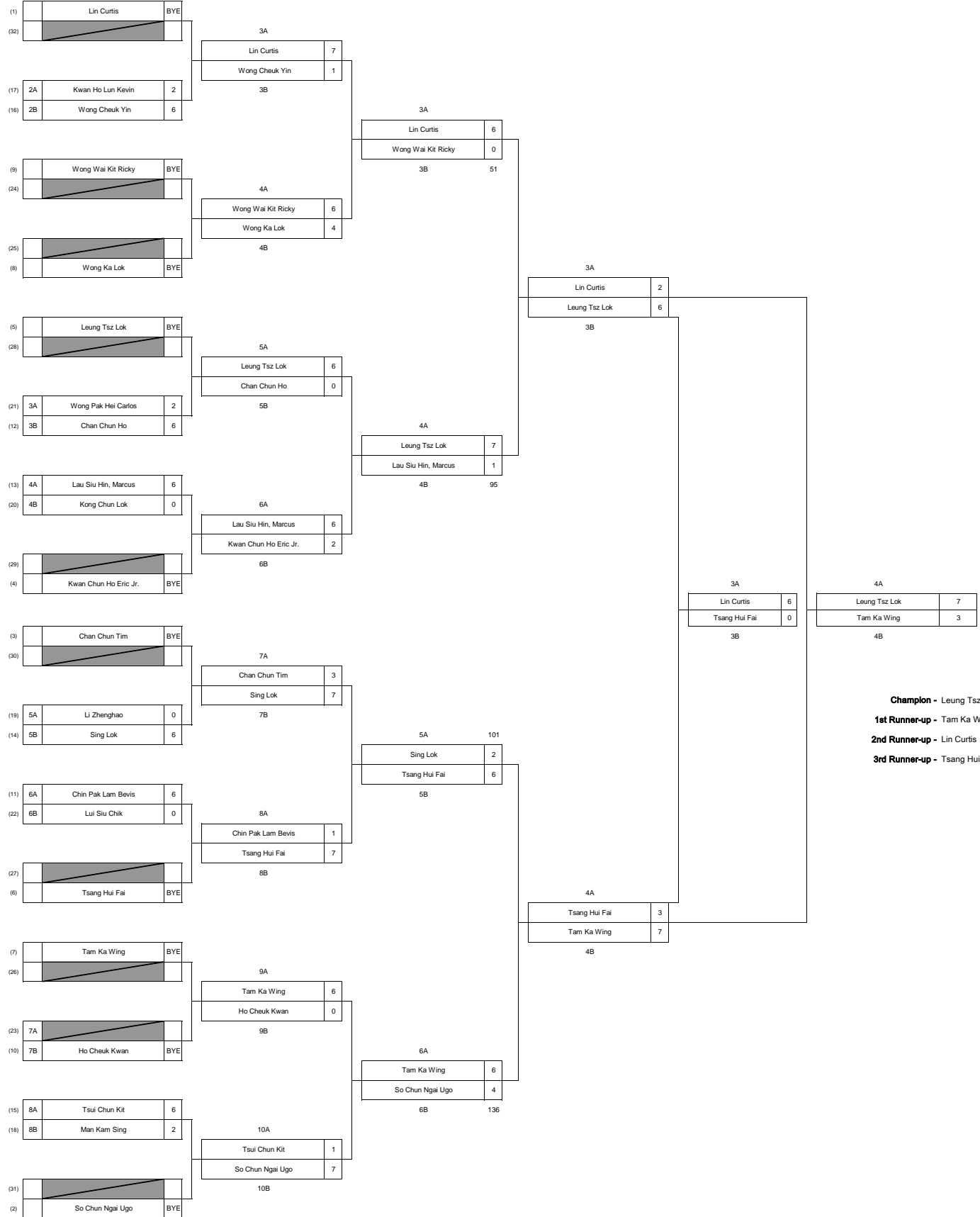

Recurve (Boy Division) Grade B Elimination Round

* Won by shoot-off

Target No. 1/16 1/8 1/4 1/2 Finals

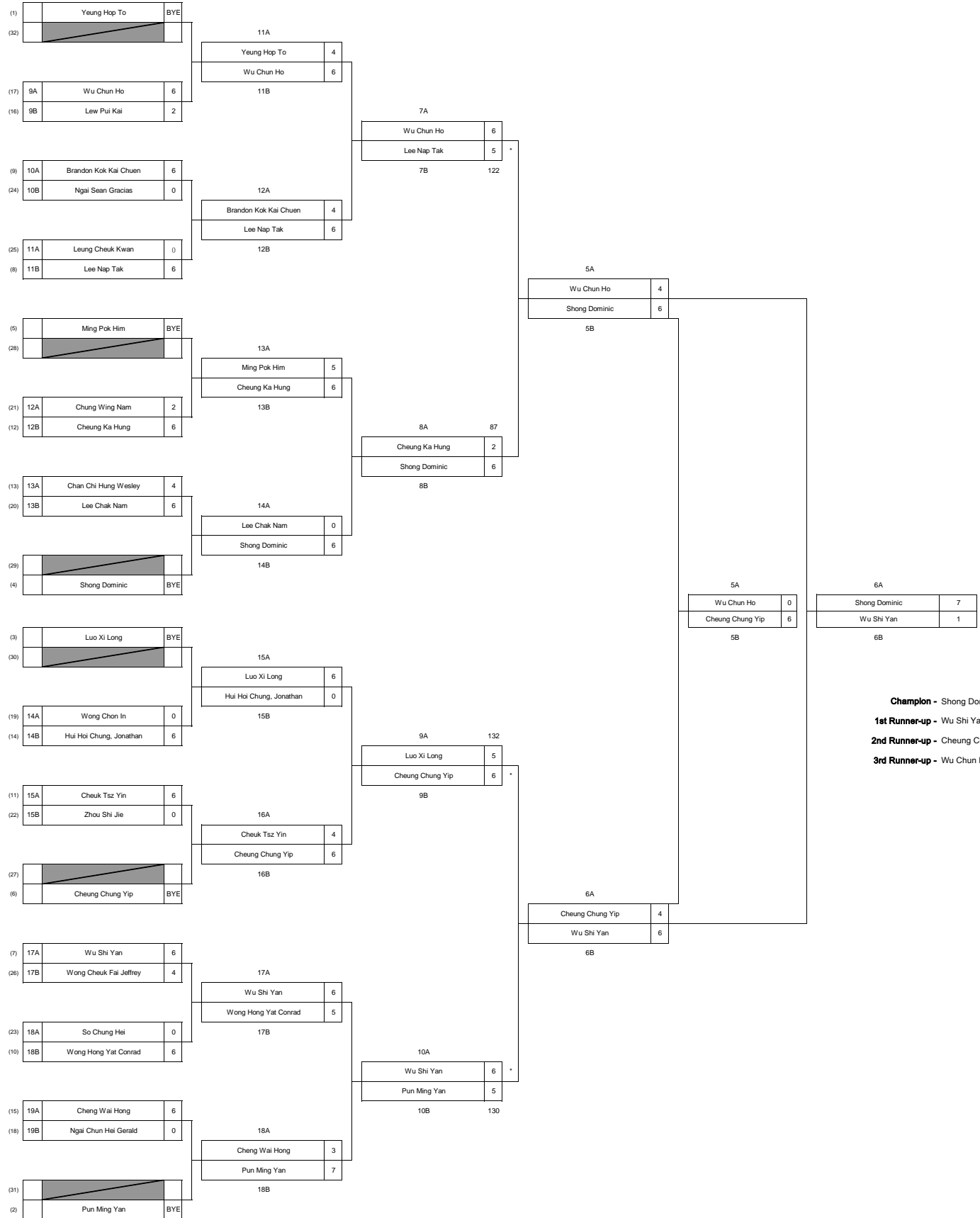

Recurve (Boy Division) Grade C Elimination Round

* Won by shoot-off

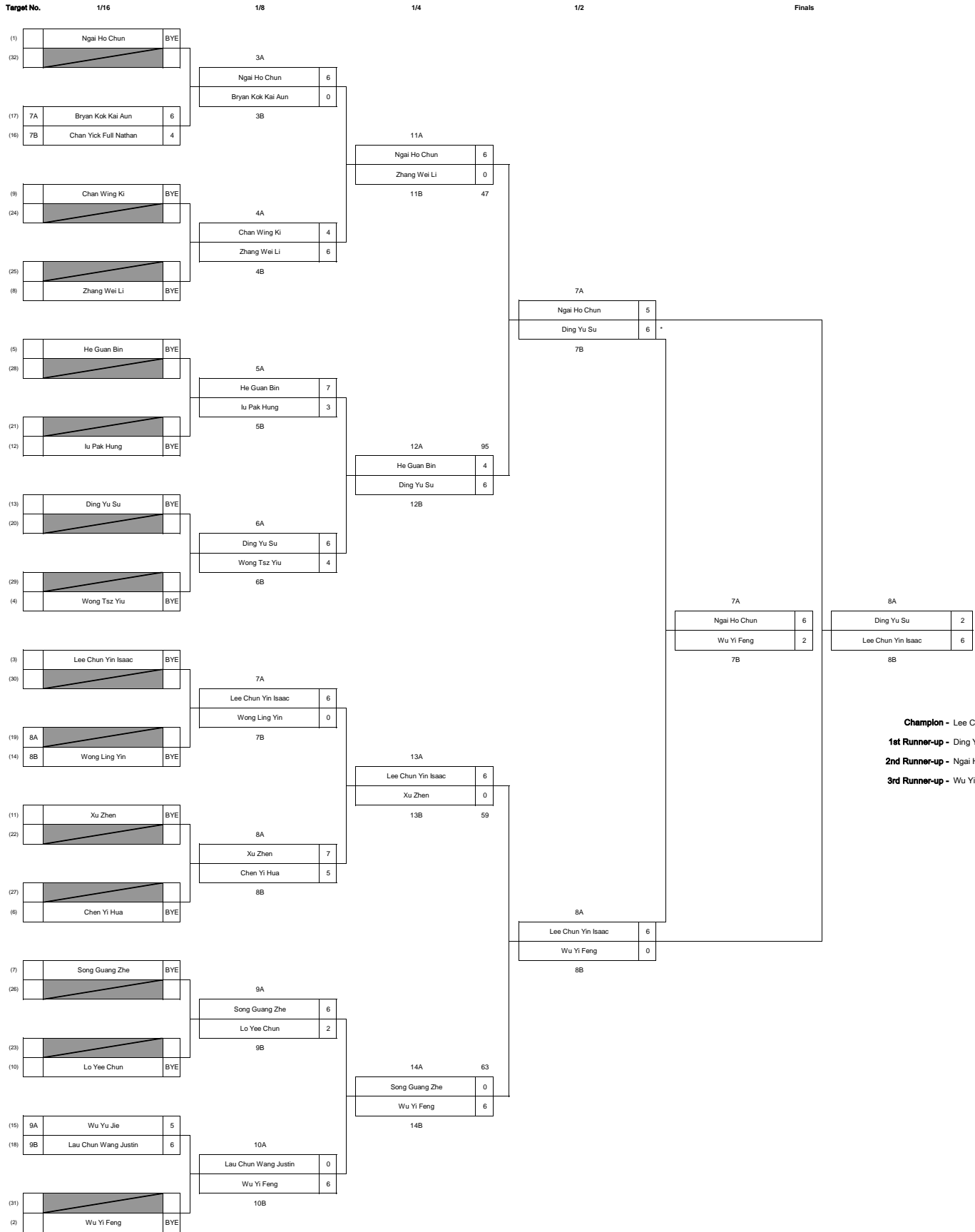

Champion - Lee Chun Yin Isaac
1st Runner-up - Ding Yu Su
2nd Runner-up - Ngai Ho Chun
3rd Runner-up - Wu Yi Feng

Recurve (Boy Division) Grade D Elimination Round

* Won by shoot-off

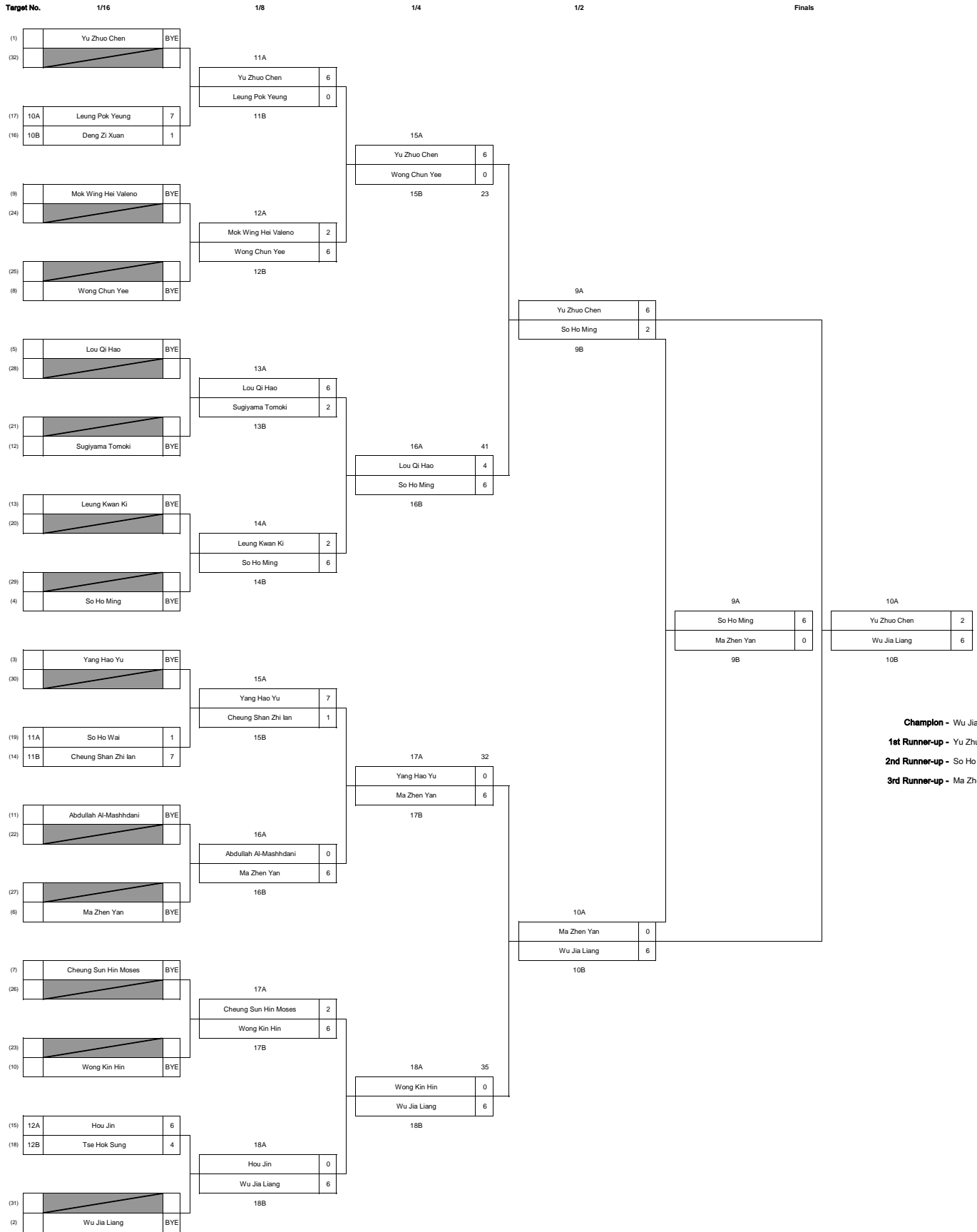

Champion - Wu Jia Liang
1st Runner-up - Yu Zhuo Chen
2nd Runner-up - So Ho Ming
3rd Runner-up - Ma Zhen Yan

Recurve (Girl Division) Grade A Elimination Round

* Won by shoot-off

Target No.	1/16	1/8	1/4	1/2	Finals																																																																																																														
(1)	Lee Shuk Kwan	BYE																																																																																																																	
(32)																																																																																																																			
(17)	1A Lam Lok Yee Ada	4																																																																																																																	
(16)	1B Mok Tsz Chin	6																																																																																																																	
(9)	Tsang Miu Hin	BYE																																																																																																																	
(24)																																																																																																																			
(25)																																																																																																																			
(8)	Wong Lok Yi	BYE																																																																																																																	
(5)	Chan Tsz Ning	BYE																																																																																																																	
(28)																																																																																																																			
(21)	2A																																																																																																																		
(12)	2B Chan Hoi Man	BYE																																																																																																																	
(13)	3A Lin Yi Kei	BYE																																																																																																																	
(20)	3B																																																																																																																		
(29)																																																																																																																			
(4)	Chin Pui Yu	BYE																																																																																																																	
(3)	Chu Man Ching	BYE																																																																																																																	
(30)																																																																																																																			
(19)	4A																																																																																																																		
(14)	4B Lai Man Ting	BYE																																																																																																																	
(11)	Leung Nga Nam	BYE																																																																																																																	
(22)																																																																																																																			
(27)																																																																																																																			
(6)	Poon Wei Tsing Natalie	BYE																																																																																																																	
(7)	Wang Cheuk Ying	BYE																																																																																																																	
(26)																																																																																																																			
(23)																																																																																																																			
(10)	Chan Bertina Wing Heng	BYE																																																																																																																	
(15)	5A OU LY	6																																																																																																																	
(18)	5B Cheung Tin Yuet	4																																																																																																																	
(31)																																																																																																																			
(2)	Ho Ching Yan	BYE																																																																																																																	
<table border="1" style="width: 100%; text-align: center;"> <tr> <td colspan="2">1A</td> </tr> <tr> <td>Lee Shuk Kwan</td> <td>6</td> </tr> <tr> <td>Mok Tsz Chin</td> <td>0</td> </tr> <tr> <td colspan="2">1B</td> </tr> <tr> <td>Lee Shuk Kwan</td> <td>6</td> </tr> <tr> <td>Tsang Miu Hin</td> <td>0</td> </tr> <tr> <td colspan="2">1B 70</td> </tr> <tr> <td colspan="2">2A</td> </tr> <tr> <td>Tsang Miu Hin</td> <td>6</td> </tr> <tr> <td>Wong Lok Yi</td> <td>0</td> </tr> <tr> <td colspan="2">2B</td> </tr> <tr> <td colspan="2">3</td> </tr> <tr> <td>Lee Shuk Kwan</td> <td>6</td> </tr> <tr> <td>Chan Tsz Ning</td> <td>2</td> </tr> <tr> <td colspan="2">4</td> </tr> <tr> <td colspan="2">2A</td> </tr> <tr> <td>Chan Tsz Ning</td> <td>6</td> </tr> <tr> <td>Lin Yi Kei</td> <td>0</td> </tr> <tr> <td colspan="2">2B 66</td> </tr> <tr> <td colspan="2">4A</td> </tr> <tr> <td>Lin Yi Kei</td> <td>6</td> </tr> <tr> <td>Chin Pui Yu</td> <td>4</td> </tr> <tr> <td colspan="2">4B</td> </tr> <tr> <td colspan="2">3</td> </tr> <tr> <td>Chan Tsz Ning</td> <td>4</td> </tr> <tr> <td>Chu Man Ching</td> <td>6</td> </tr> <tr> <td colspan="2">4</td> </tr> <tr> <td colspan="2">5</td> </tr> <tr> <td>Lee Shuk Kwan</td> <td>6</td> </tr> <tr> <td>Ho Ching Yan</td> <td>4</td> </tr> <tr> <td colspan="2">6</td> </tr> <tr> <td colspan="2">3A</td> </tr> <tr> <td>Chu Man Ching</td> <td>6</td> </tr> <tr> <td>Poon Wei Tsing Natalie</td> <td>0</td> </tr> <tr> <td colspan="2">3B 79</td> </tr> <tr> <td colspan="2">6A</td> </tr> <tr> <td>Leung Nga Nam</td> <td>2</td> </tr> <tr> <td>Poon Wei Tsing Natalie</td> <td>6</td> </tr> <tr> <td colspan="2">6B</td> </tr> <tr> <td colspan="2">5</td> </tr> <tr> <td>Chu Man Ching</td> <td>4</td> </tr> <tr> <td>Ho Ching Yan</td> <td>6</td> </tr> <tr> <td colspan="2">6</td> </tr> <tr> <td colspan="2">7A</td> </tr> <tr> <td>Wang Cheuk Ying</td> <td>6</td> </tr> <tr> <td>Chan Bertina Wing Heng</td> <td>2</td> </tr> <tr> <td colspan="2">7B</td> </tr> <tr> <td colspan="2">4A</td> </tr> <tr> <td>Wang Cheuk Ying</td> <td>0</td> </tr> <tr> <td>Ho Ching Yan</td> <td>6</td> </tr> <tr> <td colspan="2">4B 66</td> </tr> <tr> <td colspan="2">8A</td> </tr> <tr> <td>OU LY</td> <td>0</td> </tr> <tr> <td>Ho Ching Yan</td> <td>6</td> </tr> <tr> <td colspan="2">8B</td> </tr> </table>						1A		Lee Shuk Kwan	6	Mok Tsz Chin	0	1B		Lee Shuk Kwan	6	Tsang Miu Hin	0	1B 70		2A		Tsang Miu Hin	6	Wong Lok Yi	0	2B		3		Lee Shuk Kwan	6	Chan Tsz Ning	2	4		2A		Chan Tsz Ning	6	Lin Yi Kei	0	2B 66		4A		Lin Yi Kei	6	Chin Pui Yu	4	4B		3		Chan Tsz Ning	4	Chu Man Ching	6	4		5		Lee Shuk Kwan	6	Ho Ching Yan	4	6		3A		Chu Man Ching	6	Poon Wei Tsing Natalie	0	3B 79		6A		Leung Nga Nam	2	Poon Wei Tsing Natalie	6	6B		5		Chu Man Ching	4	Ho Ching Yan	6	6		7A		Wang Cheuk Ying	6	Chan Bertina Wing Heng	2	7B		4A		Wang Cheuk Ying	0	Ho Ching Yan	6	4B 66		8A		OU LY	0	Ho Ching Yan	6	8B	
1A																																																																																																																			
Lee Shuk Kwan	6																																																																																																																		
Mok Tsz Chin	0																																																																																																																		
1B																																																																																																																			
Lee Shuk Kwan	6																																																																																																																		
Tsang Miu Hin	0																																																																																																																		
1B 70																																																																																																																			
2A																																																																																																																			
Tsang Miu Hin	6																																																																																																																		
Wong Lok Yi	0																																																																																																																		
2B																																																																																																																			
3																																																																																																																			
Lee Shuk Kwan	6																																																																																																																		
Chan Tsz Ning	2																																																																																																																		
4																																																																																																																			
2A																																																																																																																			
Chan Tsz Ning	6																																																																																																																		
Lin Yi Kei	0																																																																																																																		
2B 66																																																																																																																			
4A																																																																																																																			
Lin Yi Kei	6																																																																																																																		
Chin Pui Yu	4																																																																																																																		
4B																																																																																																																			
3																																																																																																																			
Chan Tsz Ning	4																																																																																																																		
Chu Man Ching	6																																																																																																																		
4																																																																																																																			
5																																																																																																																			
Lee Shuk Kwan	6																																																																																																																		
Ho Ching Yan	4																																																																																																																		
6																																																																																																																			
3A																																																																																																																			
Chu Man Ching	6																																																																																																																		
Poon Wei Tsing Natalie	0																																																																																																																		
3B 79																																																																																																																			
6A																																																																																																																			
Leung Nga Nam	2																																																																																																																		
Poon Wei Tsing Natalie	6																																																																																																																		
6B																																																																																																																			
5																																																																																																																			
Chu Man Ching	4																																																																																																																		
Ho Ching Yan	6																																																																																																																		
6																																																																																																																			
7A																																																																																																																			
Wang Cheuk Ying	6																																																																																																																		
Chan Bertina Wing Heng	2																																																																																																																		
7B																																																																																																																			
4A																																																																																																																			
Wang Cheuk Ying	0																																																																																																																		
Ho Ching Yan	6																																																																																																																		
4B 66																																																																																																																			
8A																																																																																																																			
OU LY	0																																																																																																																		
Ho Ching Yan	6																																																																																																																		
8B																																																																																																																			

Champion - Lee Shuk Kwan
1st Runner-up - Ho Ching Yan
2nd Runner-up - Chu Man Ching
3rd Runner-up - Chan Tsz Ning

Recurve (Girl Division) Grade B Elimination Round

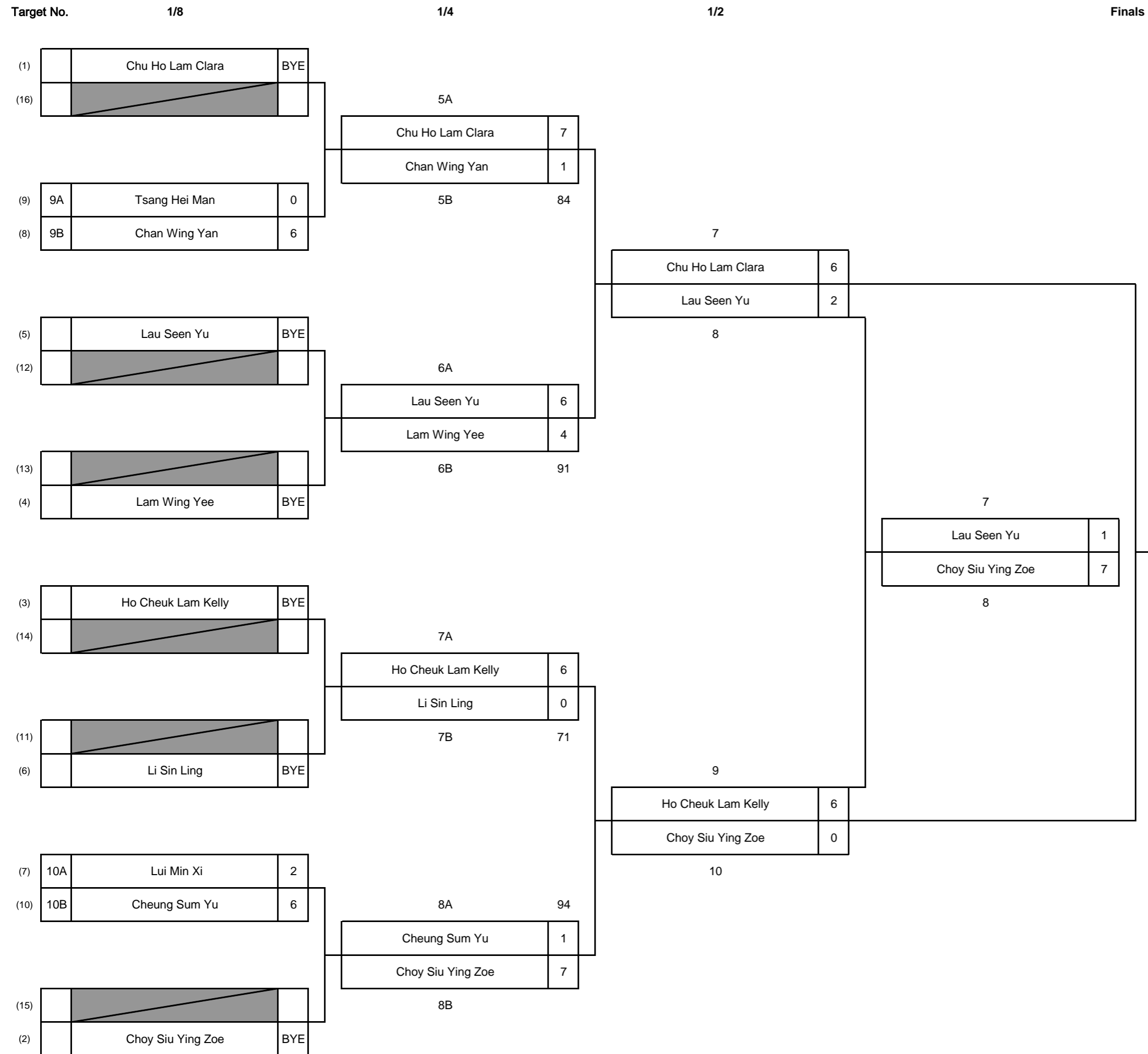

Champion - Chu Ho Lam Clara
1st Runner-up - Ho Cheuk Lam Kelly
2nd Runner-up - Choy Siu Ying Zoe
3rd Runner-up - Lau Seen Yu

Recurve (Girl Division) Grade C Elimination Round

* Won by shoot-off

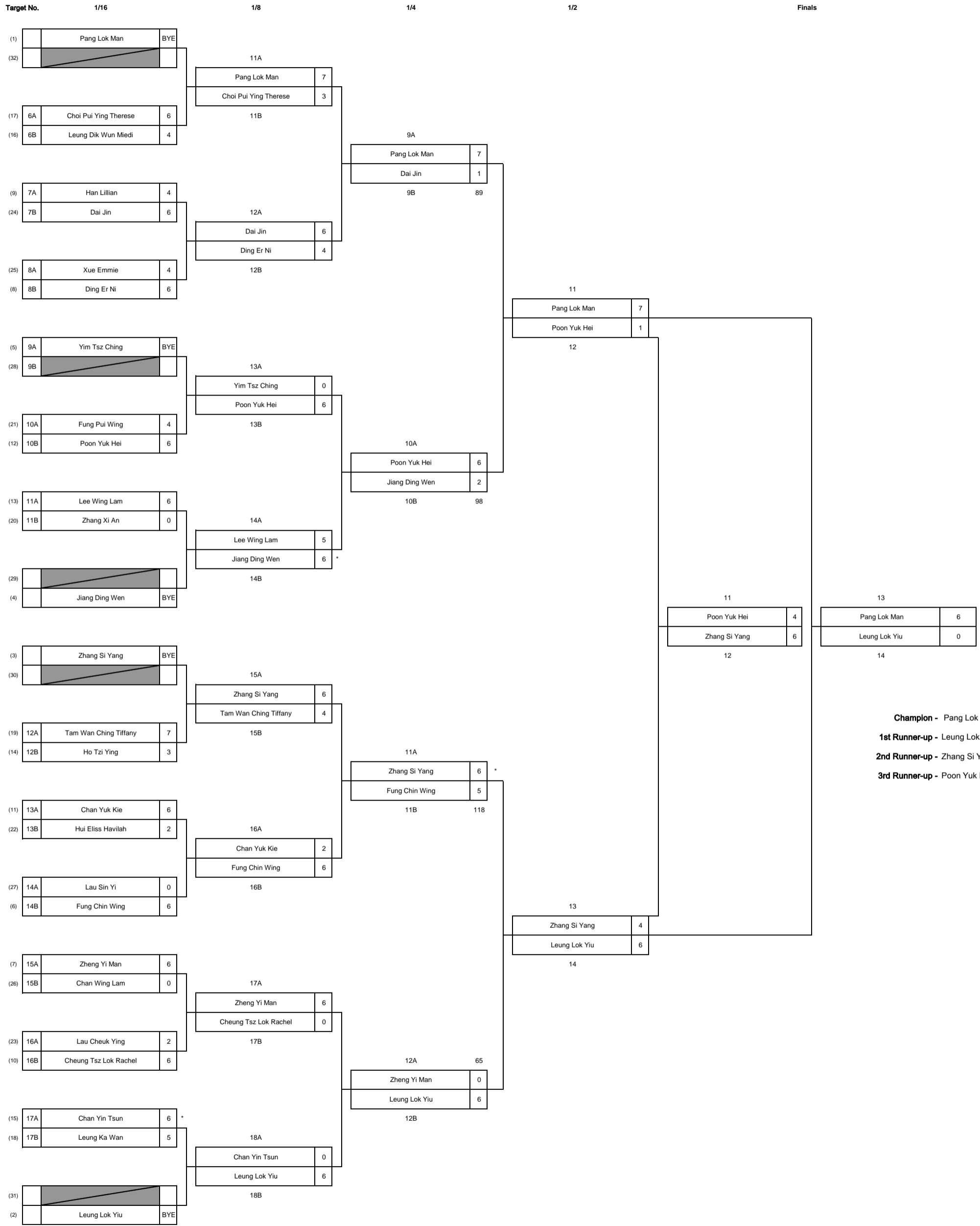

Champion - Pang Lok Man
1st Runner-up - Leung Lok Yiu
2nd Runner-up - Zhang Si Yang
3rd Runner-up - Poon Yuk Hei

Recurve (Girl Division) Grade D Elimination Round

Target No.	1/4	1/2	Finals
(1)	Tang Yi	15 Tang Yi 6 Duan Chen Xi 2	17 * Tang Yi 6 Li Jia Rong 5
(8)	BYE		
(5)	13A Li Xin Rong 4	16	18
(4)	13B Duan Chen Xi 6		
(3)	14A Luo Zhi Qi 6	17 Luo Zhi Qi 3 Li Jia Rong 7	18
(6)	14B Wen Hao Ting 2		
(7)	BYE	18	18
(2)	Li Jia Rong		

- Champion - Tang Yi**
- 1st Runner-up - Li Jia Rong**
- 2nd Runner-up - Luo Zhi Qi**
- 3rd Runner-up - Duan Chen Xi**

Compound (Boy Division) Grade A Elimination Round

* Won by shoot-off

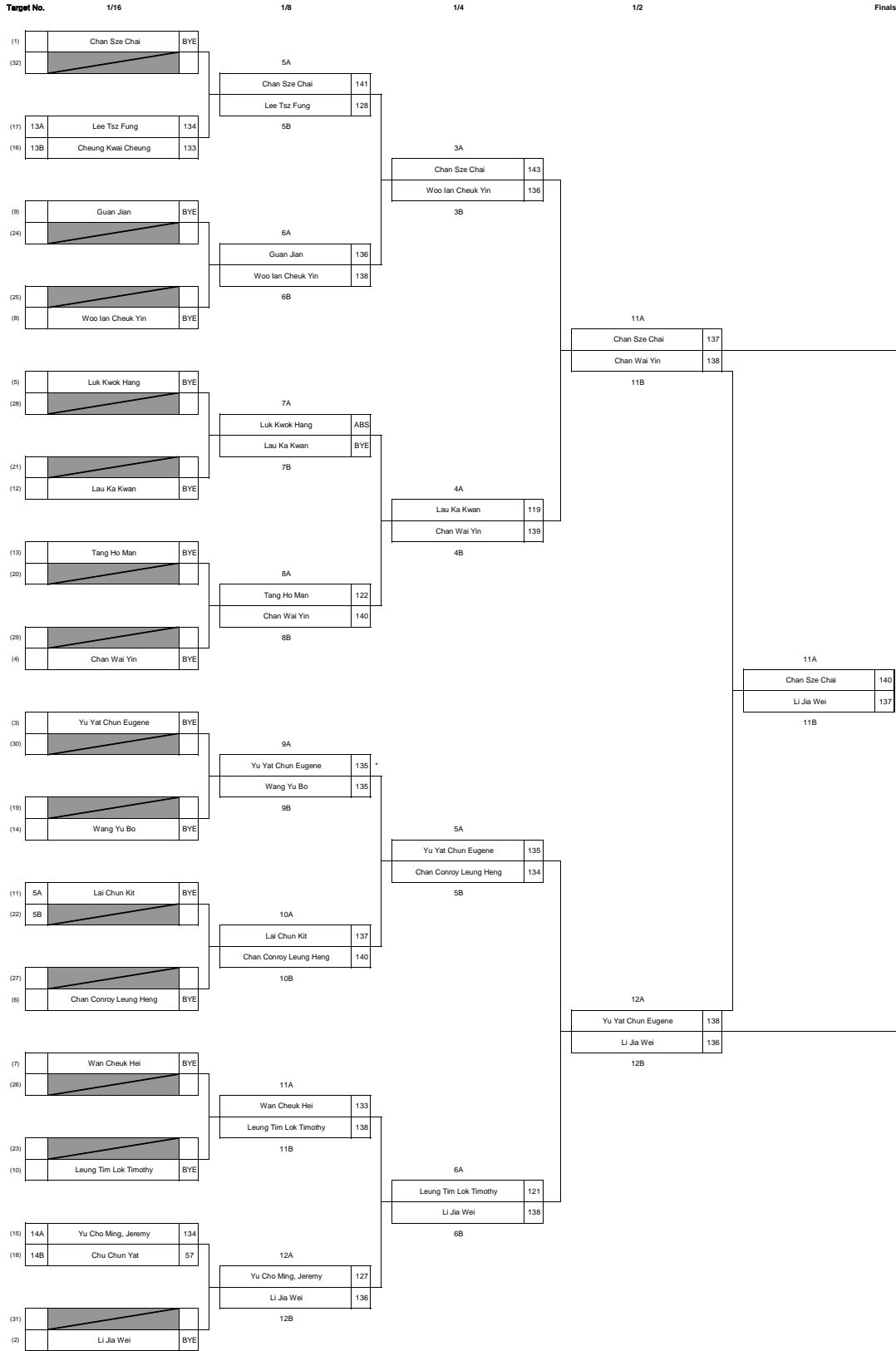

Champion - Yu Yat Chun Eugene
1st Runner-up - Chan Wai Yin
2nd Runner-up - Chan Sze Chai
3rd Runner-up - Li Jia Wei

Compound (Boy Division) Grade B Elimination Round

Target No.

1/4

1/2

Finals

(1)		He Jun Hai	BYE						
(8)									
		13A							
		He Jun Hai	138						
		Tang Cheuk Hang	134						
(5)	7A	Tang Cheuk Hang	127						
(4)	7B	Chan Chun Hei	115						
		13B							
		13A							
		Tang Cheuk Hang	131						
		Li Hoi Him	124						
		13B							
(3)	8A	Li Hoi Him	128						
(6)	8B	Lee Ka Shun	126						
		14A							
		Li Hoi Him	121						
		Chong Ho Long	136						
		14B							
(7)	9A	Li Cheng Lin	114						
(2)	9B	Chong Ho Long	136						
		14A							
		He Jun Hai	137						
		Chong Ho Long	135						
		14B							

Champion - He Jun Hai

1st Runner-up - Chong Ho Long

2nd Runner-up - Tang Cheuk Hang

3rd Runner-up - Li Hoi Him

Compound (Boy Division) Grade C Elimination Round

* Won by shoot-off

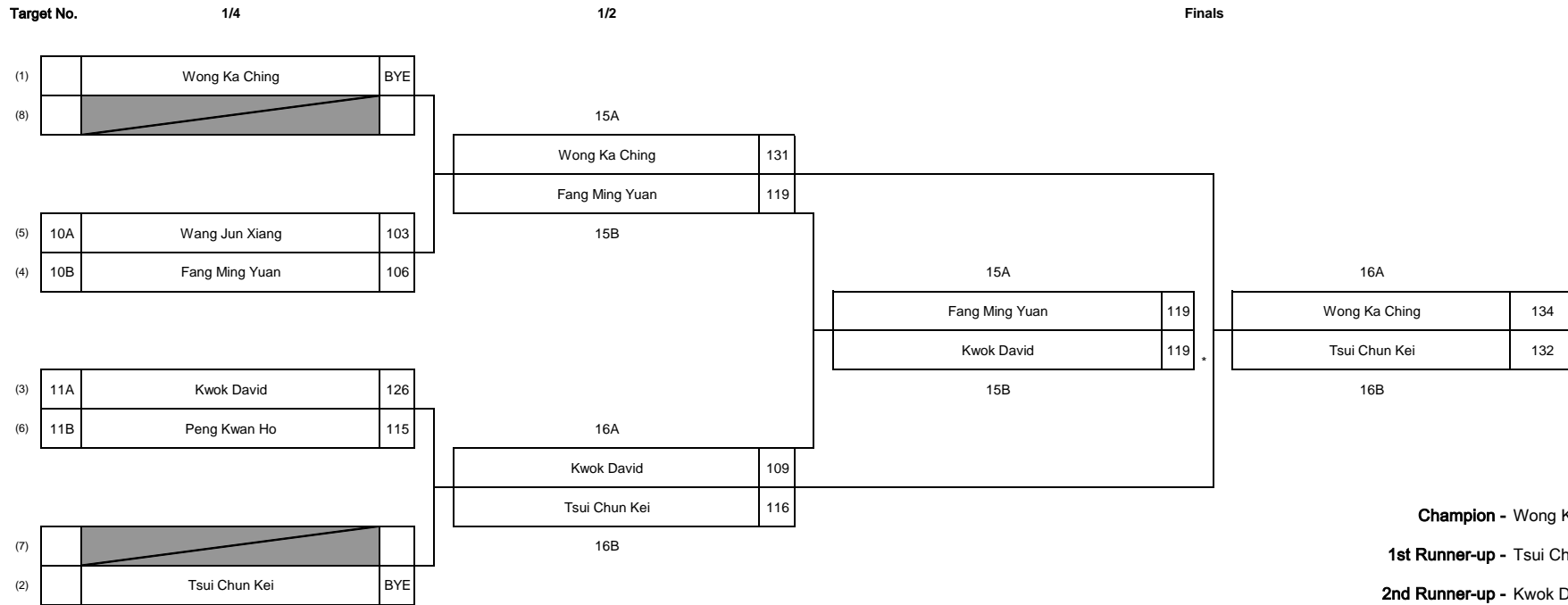

- Champion** - Wong Ka Ching
- 1st Runner-up** - Tsui Chun Kei
- 2nd Runner-up** - Kwok David
- 3rd Runner-up** - Fang Ming Yuan

Compound (Boy Division) Grade D Elimination Round

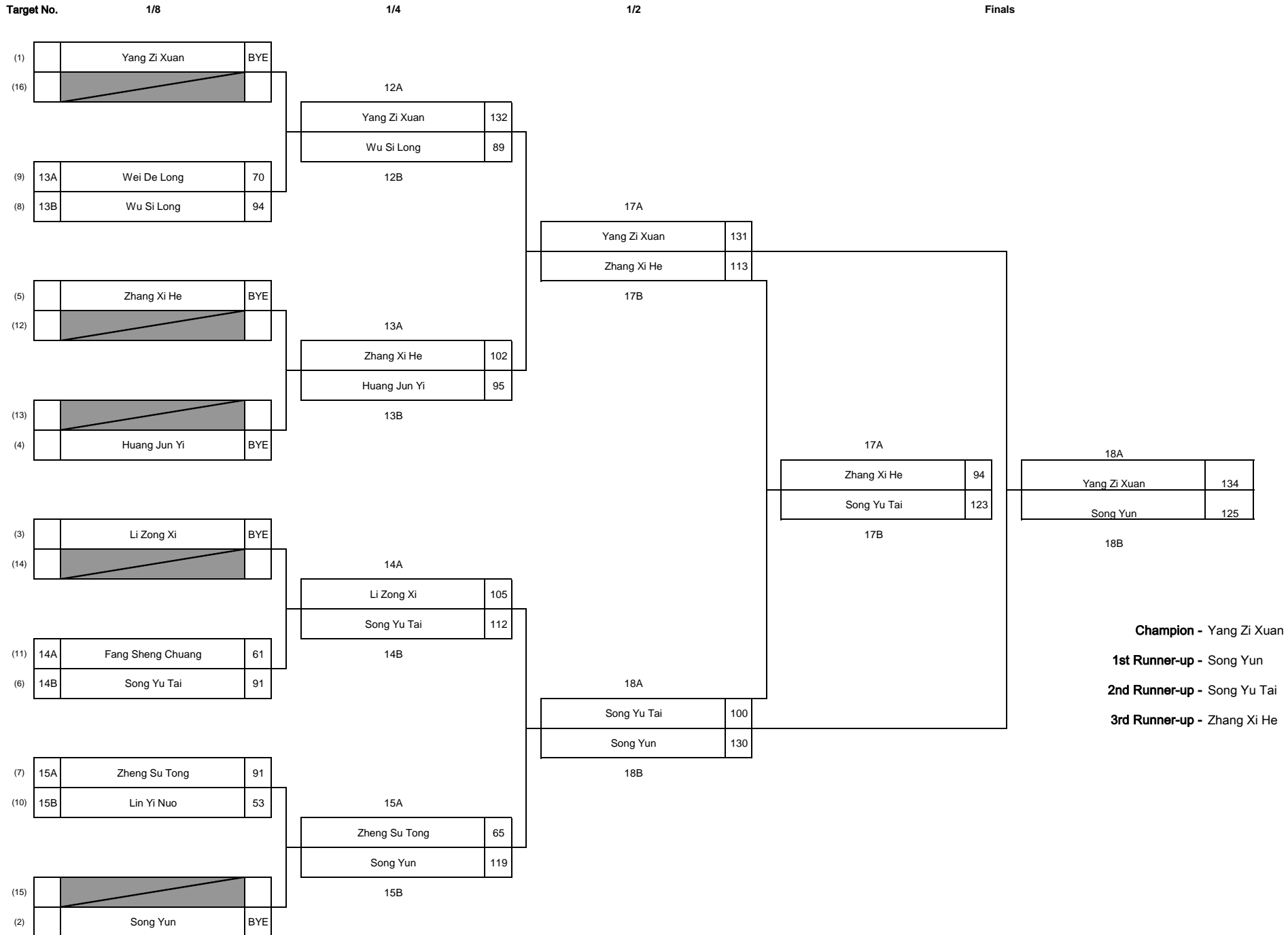

- Champion** - Yang Zi Xuan
- 1st Runner-up** - Song Yun
- 2nd Runner-up** - Song Yu Tai
- 3rd Runner-up** - Zhang Xi He

Asian Youth Indoor Archery Open (Hong Kong 2016)(Star Shoot)

26-29 Jul 2016

Tin Shui Wai Sports Centre

Result Summary

Recurve (Boy Division) Grade A

Rank	Name	Member No.	Team	YOB	QR Score	1/16	1/8	1/4	1/4 Score	1/2	Bronze	Gold
1	Leung Tsz Lok	M4260S	La Salle College (Hong Kong)	1998	516	BYE	6	7		6		7
2	Tam Ka Wing	M5860S	Shi Hui Wen Secondary School (Hong Kong)	1997	509	BYE	6	6		7		3
3	Lin Curtis	M4616S	La Salle College (Hong Kong)	1999	557	BYE	7	6		2	6	
4	Tsang Hui Fai	M5080S	St. Paul's College Archery Club (Hong Kong)	1999	511	BYE	7	6		3	0	
5	So Chun Ngai Ugo	M4257S	La Salle College (Hong Kong)	1998	544	BYE	7	4	136			
6	Sing Lok	M5788S	Hong Kong Fanling Lutheran Secondary School (Hong Kong)	1999	469	6	7	2	101			
7	Lau Siu Hin, Marcus	M4453	Police Archery Club (Hong Kong)	1998	470	6	6	1	95			
8	Wong Wai Kit Ricky	M6044S	Hong Kong Institute of Vocational Education (Shatin) (Hong Kong)	1996	489	BYE	6	0	51			
9	Wong Ka Lok	M4435S	Police Archery Club (Hong Kong)	1998	508	BYE	4					
9	Chan Chun Tim	M5405S	Hong Kong Paralympic Committee & Sports Association for the Physically Disabled (Hong Kong)	1997	538	BYE	3					
9	Kwan Chun Ho Eric Jr.	M4750S	Police Archery Club (Hong Kong)	1997	528	BYE	2					
9	Wong Cheuk Yin	M6113S	Hong Kong Institute of Vocational Education (Shatin) (Hong Kong)	1997	430	6	1					
9	Tsui Chun Kit	Temp	N.L.S.I. Lui Kwok Pat Fong College (Hong Kong)	1999	467	6	1					
9	Chin Pak Lam Bevis	Temp	N.L.S.I. Lui Kwok Pat Fong College (Hong Kong)	1999	474	6	1					
9	Ho Cheuk Kwan	M4572S	S T F A Tam Pak Yu College (Hong Kong)	1999	478	BYE	0					
9	Chan Chun Ho	M5886S	Shatin Sports Association Archery Club (Hong Kong)	1998	474	6	0					
17	Wong Pak Hei Carlos	M6108S	Hong Kong Institute of Vocational Education (Shatin) (Hong Kong)	1996	211	2						
17	Kwan Ho Lun Kevin	M6073S	HKUST (Hong Kong)	1997	426	2						
17	Man Kam Sing	M6107S	Hong Kong Institute of Vocational Education (Shatin) (Hong Kong)	1997	414	2						
17	Kong Chun Lok	M6311S	St. Paul's College Archery Club (Hong Kong)	1998	257	0						
17	Lui Siu Chik	M5365S	North District Archery Club (Hong Kong)	1997	52	0						
17	Li Zhenghao	M4973S	HKMA K. S. Lo College (Hong Kong)	1999	410	0						
ABS	Wan Ho Hin	M4869S	Hong Kong Fanling Lutheran Secondary School Archery Club (Hong Kong)	1998	0							

Recurve (Boy Division) Grade B

Rank	Name	Member No.	Team	YOB	QR Score	1/16	1/8	1/4	1/4 Score	1/2	Bronze	Gold
1	Shong Dominic	M5867S	HK Youth Archery Squad (Hong Kong)	2001	523	BYE	6	6		6		7
2	Wu Shi Yan	M5791S	Hong Kong Fanling Lutheran Secondary School (Hong Kong)	2001	499	6	6	6		6		1
3	Cheung Chung Yip	M5048S	STFA Seaward Woo College Archery Club (Hong Kong)	2000	508	BYE	6	6		4	6	
4	Wu Chun Ho	M5645S	S T F A Tam Pak Yu College (Hong Kong)	2000	432	6	6	6		4	0	
5	Luo Xi Long	Temp	FuTian Shejian Association	2000	525	BYE	6	5	132			
6	Pun Ming Yan	M6184S	HKMA K. S. Lo College (Hong Kong)	2001	533	BYE	7	5	130			
7	Lee Nap Tak	M5453S	STFA Seaward Woo College Archery Club (Hong Kong)	2001	486	6	6	5	122			
8	Cheung Ka Hung	M6012S	Shun Tak Fraternal Association Seaward Woo College (Hong Kong)	2001	469	6	6	2	87			
9	Ming Pok Him	M4870S	HK Youth Archery Squad (Hong Kong)	2000	510	BYE	5					
9	Wong Hong Yat Conrad	M5325S	La Salle College Archery Club (Hong Kong)	2000	478	6	5					
9	Yeung Hop To	M5354S	La Salle College Archery Club (Hong Kong)	2000	534	BYE	4					
9	Brandon Kok Kai Chuen	G6294S	Shekou International School	2001	481	6	4					
9	Cheuk Tsz Yin	M4144S	HK Youth Archery Squad (Hong Kong)	2001	470	6	4					
9	Cheng Wai Hong	M6172S	S T F A Tam Pak Yu College (Hong Kong)	2001	445	6	3					
9	Hui Hoi Chung, Jonathan	M3717S	Eastman Archery Club (Hong Kong)	2000	450	6	0					
9	Lee Chak Nam	M5946S	Eastman Archery Club (Hong Kong)	2001	378	6	0					
17	Chan Chi Hung Wesley	Temp	South Island School (Hong Kong)	2001	464	4						
17	Wong Cheuk Fai Jeffrey	M5686S	St. Paul's College Archery Club (Hong Kong)	2001	216	4						
17	Lew Pui Kai	M5326S	La Salle College Archery Club (Hong Kong)	2001	435	2						
17	Chung Wing Nam	M5450S	Shun Tak Fraternal Association Seaward Woo College (Hong Kong)	2001	369	2						
17	Zhou Shi Jie	Temp	Shanghai Hongkou Experimental School	2001	352	0						
17	So Chung Hei	M5327S	La Salle College Archery Club (Hong Kong)	2000	348	0						
17	Wong Chon In	M5543S	Ho Yu College and Primary School (Sponsored By Sik Sik Yuen) (Hong Kong)	2001	417	0						
17	Ngai Chun Hei Gerald	Temp	St. Paul's College Archery Club (Hong Kong)	2000	423	0						
17	Ngai Sean Gracias	Temp	St. Paul's College Archery Club (Hong Kong)	2000	300	0						
17	Leung Cheuk Kwan	M5452S	Shun Tak Fraternal Association Seaward Woo College (Hong Kong)	2001	266	0						
ABS	Wong Ka Lok	M4971S	HKMA K. S. Lo College (Hong Kong)	2000	0							

Asian Youth Indoor Archery Open (Hong Kong 2016)(Star Shoot)

26-29 Jul 2016

Tin Shui Wai Sports Centre

Result Summary

Recurve (Boy Division) Grade C

Rank	Name	Member No.	Team	YOB	QR Score	1/16	1/8	1/4	1/4 Score	1/2	Bronze	Gold
1	Lee Chun Yin Isaac	M5982S	La Salle College Archery Club (Hong Kong)	2002	517	BYE	6	6		6		6
2	Ding Yu Su	Temp	Shanghai Hongkou Experimental School	2003	389	BYE	6	6		6		2
3	Ngai Ho Chun	M5765S	St. Paul's College Archery Club (Hong Kong)	2002	528	BYE	6	6		5	6	
4	Wu Yi Feng	Temp	FuTian Shejian Association	2002	519	BYE	6	6		0	2	
5	He Guan Bin	Temp	FuTian Shejian Association	2002	495	BYE	7	4	95			
6	Song Guang Zhe	Temp	Shanghai Hongkou Experimental School	2002	491	BYE	6	0	63			
7	Xu Zhen	Temp	FuTian Shejian Association	2003	438	BYE	7	0	59			
8	Zhang Wei Li	Temp	Shanghai Hongkou Experimental School	2003	474	BYE	6	0	47			
9	Chen Yi Hua	Temp	Shanghai Bowsac Archery Club	2003	492	BYE	5					
9	Wong Tsz Yiu	M5793S	HK Youth Archery Squad (Hong Kong)	2002	498	BYE	4					
9	Chan Wing Ki	M6167S	Hong Kong Fanling Lutheran Secondary School (Hong Kong)	2003	458	BYE	4					
9	Iu Pak Hung	M6165S	Hong Kong Fanling Lutheran Secondary School Archery Club (Hong Kong)	2002	431	BYE	3					
9	Lo Yee Chun	M5921S	La Salle College Archery Club (Hong Kong)	2002	443	BYE	2					
9	Lau Chun Wang Justin	Temp	St. Paul's College Archery Club (Hong Kong)	2003	196	6	0					
9	Bryan Kok Kai Aun	G6293S	Shekou International School	2003	277	6	0					
9	Wong Ling Yin	Temp	Diocesan Boys' School (Hong Kong)	2003	378	BYE	0					
17	Wu Yu Jie	Temp	Shanghai Bowsac Archery Club	2002	342	5						
17	Chan Yick Full Nathan	M6250S	St. Paul's College Archery Club (Hong Kong)	2003	301	4						
ABS	Chan Chun On	M6162S	Hong Kong Fanling Lutheran Secondary School (Hong Kong)	2002	0							

Recurve (Boy Division) Grade D

Rank	Name	Member No.	Team	YOB	QR Score	1/16	1/8	1/4	1/4 Score	1/2	Bronze	Gold
1	Wu Jia Liang	Temp	Shanghai Songjiang Sijing Youth Archery Team	2004	403	BYE	6	6		6		6
2	Yu Zhuo Chen	Temp	FuTian Shejian Association	2006	417	BYE	6	6		6		2
3	So Ho Ming	M6302S	Golden Trust Archery Club (Hong Kong)	2005	322	BYE	6	6		2	6	
4	Ma Zhen Yan	Temp	Shanghai Songjiang Sijing Youth Archery Team	2005	295	BYE	6	6		0	0	
5	Lou Qi Hao	Temp	Shanghai Songjiang Sijing Youth Archery Team	2004	308	BYE	6	4	41			
6	Yang Hao Yu	Temp	Shanghai Songjiang Sijing Youth Archery Team	2005	325	BYE	7	0	32			
7	Wong Kin Hin	M5821S	The Scout Association of Hong Kong (Hong Kong)	2004	200	BYE	6	0	30			
8	Wong Chun Yee	M4633S	The Scout Association of Hong Kong (Hong Kong)	2005	244	BYE	6	0	23			
9	Cheung Sun Hin Moses	Temp	North District Archery Club (Hong Kong)	2004	273	BYE	2					
9	Leung Kwan Ki	M6056S	North District Archery Club (Hong Kong)	2004	167	BYE	2					
9	Sugiyama Tomoki	G6295S	Shekou International School	2004	182	BYE	2					
9	Mok Wing Hei Valeno	M4728S	The Scout Association of Hong Kong (Hong Kong)	2004	210	BYE	2					
9	Cheung Shan Zhi Ian	Temp	Police Archery Club (Hong Kong)	2004	153	7	1					
9	Hou Jin	Temp	Shanghai Songjiang Sijing Youth Archery Team	2005	138	6	0					
9	Leung Pok Yeung	M5810S	The Scout Association of Hong Kong (Hong Kong)	2007	100	7	0					
9	Abdullah Al-Mashhdani	Temp	Iraqi Archery Federation	2006	190	BYE	0					
17	Tse Hok Sung	M6299S	Golden Trust Archery Club (Hong Kong)	2005	61	4						
17	So Ho Wai	M6301S	Golden Trust Archery Club (Hong Kong)	2008	15	1						
17	Deng Zi Xuan	Temp	Shanghai Songjiang Sijing Youth Archery Team	2005	124	1						

Asian Youth Indoor Archery Open (Hong Kong 2016)(Star Shoot)

26-29 Jul 2016

Tin Shui Wai Sports Centre

Result Summary

Recurve (Girl Division) Grade A

Rank	Name	Member No.	Team	YOB	QR Score	1/16	1/8	1/4	1/4 Score	1/2	Bronze	Gold
1	Lee Shuk Kwan	M4381S	HKUST (Hong Kong)	1997	542	BYE	6	6		6		6
2	Ho Ching Yan	M5534S	Pui Ching Middle School (Hong Kong)	1999	528	BYE	6	6		6		4
3	Chu Man Ching	M4438S	True Light Archery Club (Hong Kong)	1997	516	BYE	6	6		4	6	
4	Chan Tsz Ning	M4683S	Hong Kong True Light College (Hong Kong)	1999	512	BYE	6	6		2	4	
5	Poon Wei Tsing Natalie	M5533S	Pui Ching Middle School (Hong Kong)	1999	509	BYE	6	0	79			
6	Tsang Miu Hin	M5536S	Pui Ching Middle School (Hong Kong)	1999	496	BYE	6	0	70			
7	Lin Yi Kei	M4011S	Hong Kong Fanling Lutheran Secondary School Archery Club (Hong Kong)	1997	450	BYE	6	0	66			
7	Wang Cheuk Ying	M4355S	True Light Archery Club (Hong Kong)	1998	502	BYE	6	0	66			
9	Chin Pui Yu	M6181S	Christian Zheng Sheng College (Hong Kong)	1998	513	BYE	4					
9	Chan Bertina Wing Heng	M3757S	Eastman Archery Club (Hong Kong)	1996	494	BYE	2					
9	Leung Nga Nam	M6182S	Christian Zheng Sheng College (Hong Kong)	1998	494	BYE	2					
9	Mok Tsz Chin	M3545S	North District Archery Club (Hong Kong)	1998	403	6	0					
9	OU LY	M5421S	STFA Seaward Woo College Archery Club (Hong Kong)	1999	419	6	0					
9	Lai Man Ting	M6284S	Christian Zheng Sheng College (Hong Kong)	1996	428	BYE	0					
9	Wong Lok Yi	M5719S	Christian Zheng Sheng College (Hong Kong)	1999	498	BYE	0					
9	Chan Hoi Man	M4678S	True Light Archery Club (Hong Kong)	1997	462	BYE	0					
17	Cheung Tin Yuet	M4522S	Hong Kong Fanling Lutheran Secondary School (Hong Kong)	1999	267	4						
17	Lam Lok Yee Ada	M6206S	HKUST (Hong Kong)	1996	350	4						
17	Chung Ching In	M4681S	Hong Kong True Light College (Hong Kong)	1999	0							
17	Cheung Wing Sze	Temp	Christian Zheng Sheng College (Hong Kong)	1998	0							
17	Wong Ting	Temp	N.L.S.I. Lui Kwok Pat Fong College (Hong Kong)	1999	0							

Asian Youth Indoor Archery Open (Hong Kong 2016)(Star Shoot)

26-29 Jul 2016

Tin Shui Wai Sports Centre

Result Summary

Recurve (Girl Division) Grade B

Rank	Name	Member No.	Team	YOB	QR Score	1/8	1/4	1/4 Score	1/2	Bronze	Gold
1	Chu Ho Lam Clara	M5381S	True Light Archery Club (Hong Kong)	2001	529	BYE	7		6		6
2	Ho Cheuk Lam Kelly	M5424S	Hong Kong Fanling Lutheran Secondary School (Hong Kong)	2001	504	BYE	6		6		0
3	Choy Siu Ying Zoe	M5418S	HK Youth Archery Squad (Hong Kong)	2001	509	BYE	7		0	7	
4	Lau Seen Yu	M5734S	Hong Kong True Light College (Hong Kong)	2001	471	BYE	6		2	1	
5	Cheung Sum Yu	M6257S	Christian Zheng Sheng College (Hong Kong)	2000	338	6	1	94			
6	Lam Wing Yee	M5417S	HK Youth Archery Squad (Hong Kong)	2001	491	BYE	4	91			
7	Chan Wing Yan	M5448S	Shun Tak Fraternal Association Seaward Woo College (Hong Kong)	2001	452	6	1	84			
8	Li Sin Ling	M5397S	True Light Archery Club (Hong Kong)	2001	459	BYE	0	71			
9	Lui Min Xi	M6092S	The Chinese Foundation Secondary School (Hong Kong)	2000	453	2					
9	Tsang Hei Man	M5049S	Shun Tak Fraternal Association Seaward Woo College (Hong Kong)	2000	432	0					

Asian Youth Indoor Archery Open (Hong Kong 2016)(Star Shoot)

26-29 Jul 2016

Tin Shui Wai Sports Centre

Result Summary

Recurve (Girl Division) Grade C

Rank	Name	Member No.	Team	YOB	QR Score	1/16	1/8	1/4	1/4 Score	1/2	Bronze	Gold
1	Pang Lok Man	M4946S	Police Archery Club (Hong Kong)	2002	523	BYE	7	7		7		6
2	Leung Lok Yiu	M5735S	Hong Kong True Light College (Hong Kong)	2002	515	BYE	6	6		6		0
3	Zhang Si Yang	Temp	Shanghai Hongkou Experimental School	2003	495	BYE	6	6		4	6	
4	Poon Yuk Hei	M5902S	STFA Seaward Woo College Archery Club (Hong Kong)	2002	398	6	6	6		1	4	
5	Fung Chin Wing	M5576S	Police Archery Club (Hong Kong)	2002	456	6	6	5	118			
6	Jiang Ding Wen	Temp	Shanghai Bowsac Archery Club	2002	486	BYE	6	2	98			
7	Dai Jin	G6300S	Golden Trust Archery Club (China)	2003	292	6	6	1	89			
8	Zheng Yi Man	Temp	FuTian Shejian Association	2002	452	6	6	0	65			
9	Lee Wing Lam	M5969S	True Light Archery Club (Hong Kong)	2003	372	6	5					
9	Ding Er Ni	Temp	Shanghai Hongkou Experimental School	2003	438	6	4					
9	Tam Wan Ching Tiffany	M6200S	HKMA K. S. Lo College (Hong Kong)	2002	341	7	4					
9	Chan Yuk Kie	M6111S	The Chinese Foundation Secondary School (Hong Kong)	2002	406	6	2					
9	Chan Yuk Kie	M6111S	The Chinese Foundation Secondary School (Hong Kong)	2002	406	6	2					
9	Chan Yin Tsun	M5967S	Hong Kong True Light College (Hong Kong)	2002	368	6	0					
9	Yim Tsz Ching	M5787S	Hong Kong Fanling Lutheran Secondary School (Hong Kong)	2002	456	BYE	0					
9	Cheung Tsz Lok Rachel	M5961S	Police Archery Club (Hong Kong)	2003	407	6	0					
17	Leung Ka Wan	Temp	South Island School (Hong Kong)	2003	345	5						
17	Xue Emmie	G6291S	Shekou International School	2003	286	4						
17	Han Lillian	G6297S	Shekou International School	2003	408	4						
17	Fung Pui Wing	M6090S	Good Hope School (Hong Kong)	2002	318	4						
17	Leung Dik Wun Miedi	M6000S	True Light Archery Club (Hong Kong)	2002	359	4						
17	Ho Tzi Ying	M6201S	HKMA K. S. Lo College (Hong Kong)	2002	370	3						
17	Lau Cheuk Ying	M5986S	North District Archery Club (Hong Kong)	2003	295	2						
17	Hui Eliss Havilah	M5809S	North District Archery Club (Hong Kong)	2003	315	2						
17	Zhang Xi An	Temp	Shanghai Hongkou Experimental School	2002	322	0						
17	Lau Sin Yi	M5968S	Hong Kong True Light College (Hong Kong)	2003	160	0						
17	Chan Wing Lam	M6175S	True Light Archery Club (Hong Kong)	2002	177	0						
ABS	Chan Yui Yan	M6195S	HKMA K. S. Lo College (Hong Kong)	2002	0							

Recurve (Girl Division) Grade D

Rank	Name	Member No.	Team	YOB	QR Score	1/4	1/4 Score	1/2	Bronze	Gold
1	Tang Yi	Temp	FuTian Shejian Association	2005	374	BYE		6		6
2	Li Jia Rong	Temp	Shanghai Hongkou Experimental School	2004	317	BYE		7		5
3	Luo Zhi Qi	Temp	Shanghai Hongkou Experimental School	2004	302	6		3	6	
4	Duan Chen Xi	Temp	FuTian Shejian Association	2005	241	6		2	2	
5	Li Xin Rong	Temp	FuTian Shejian Association	2004	223	4	82			
6	Wen Hao Ting	M6298S	Golden Trust Archery Club (Hong Kong)	2006	156	2	25			

Asian Youth Indoor Archery Open (Hong Kong 2016)(Star Shoot)

26-29 Jul 2016

Tin Shui Wai Sports Centre

Result Summary

Compound (Boy Division) Grade A

* Won by shoot-off

Rank	Name	Member No.	Team	YOB	QR Score	1/16	1/8	1/4	1/2	Bronze	Gold
1	Yu Yat Chun Eugene	M4621S	La Salle College Archery Club (Hong Kong)	1999	559	BYE	135	135	138		140*
2	Chan Wai Yin	M4478S	(Hong Kong) Tai Po 08 Archery Club (Hong Kong)	1999	553	BYE	140	139	138		140
3	Chan Sze Chai	M4470S	Diocesan Boys' School (Hong Kong)	1996	565	BYE	141	143	137	140	
4	Li Jia Wei	Temp	Changzhou Elite Archery Sport Club	1997	559	BYE	136	138	136	137	
5	Woo Ian Cheuk Yin	M6267S	Diocesan Boys' School (Hong Kong)	1998	544	BYE	138	136			
6	Chan Conroy Leung Heng	M4418S	La Salle College Archery Club (Hong Kong)	1999	548	BYE	140	134			
7	Leung Tim Lok Timothy	M4324S	Shau Kei Wan Government Secondary School (Hong Kong)	1997	538	BYE	138	121			
8	Lau Ka Kwan	M4197S	STFA Seaward Woo College Archery Club (Hong Kong)	1997	537	BYE	BYE	119			
9	Lai Chun Kit	M4619S	La Salle College Archery Club (Hong Kong)	1998	537	BYE	137				
9	Guan Jian	Temp	Changzhou Elite Archery Sport Club	1996	542	BYE	136				
9	Wang Yu Bo	Temp	Beijing National Day School	1999	522	BYE	135				
9	Wan Cheuk Hei	M4548S	North District Archery Club (Hong Kong)	1997	545	BYE	133				
9	Lee Tsz Fung	M4325S	Shau Kei Wan Government Secondary School (Hong Kong)	1997	513	134	128				
9	Yu Cho Ming, Jeremy	M4472S	Diocesan Boys' School (Hong Kong)	1998	522	134	127				
9	Tang Ho Man	M3589S	Kowloon Archery Club (Hong Kong)	1997	536	BYE	122				
9	Luk Kwok Hang	M5050S	STFA Seaward Woo College Archery Club (Hong Kong)	1998	552	BYE	ABS				
17	Cheung Kwai Cheung	M4877S	HK Youth Archery Squad (Hong Kong)	1998	520	133					
17	Chu Chun Yat	M4293S	St. Paul's College Archery Club (Hong Kong)	1998	354	57					

Compound (Boy Division) Grade B

Rank	Name	Member No.	Team	YOB	QR Score	1/4	1/2	Bronze	Gold
1	He Jun Hai	Temp	FuTian Shejian Association	2000	550	BYE	138		137
2	Chong Ho Long	M5891S	HKMA K. S. Lo College (Hong Kong)	2000	518	136	136		135
3	Tang Cheuk Hang	M5581S	HKMA K. S. Lo College (Hong Kong)	2000	479	127	134	131	
4	Li Hoi Him	M5413S	St. Paul's College Archery Club (Hong Kong)	2001	501	128	121	124	
5	Lee Ka Shun	M5597S	HKMA K. S. Lo College (Hong Kong)	2001	463	126			
6	Chan Chun Hei	M5468S	Hong Kong Fanling Lutheran Secondary School (Hong Kong)	2001	491	115			
7	Li Cheng Lin	Temp	FuTian Shejian Association	2001	346	114			

Compound (Boy Division) Grade C

* Won by shoot-off

Rank	Name	Member No.	Team	YOB	QR Score	1/4	1/2	Bronze	Gold
1	Wong Ka Ching	M5910S	St. Paul's College Archery Club (Hong Kong)	2002	546	BYE	131		134
2	Tsui Chun Kei	M3548S	Police Archery Club (Hong Kong)	2002	492	BYE	116		132
3	Kwok David	M6168S	Hong Kong Fanling Lutheran Secondary School (Hong Kong)	2003	466	126	109	119*	
4	Fang Ming Yuan	Temp	FuTian Shejian Association	2002	416	106	119		119
5	Peng Kwan Ho	M6159S	Hong Kong Fanling Lutheran Secondary School (Hong Kong)	2002	411	115			
6	Wang Jun Xiang	Temp	FuTian Shejian Association	2004	413	103			

Compound (Boy Division) Grade D

Rank	Name	Member No.	Team	YOB	QR Score	1/8	1/4	1/2	Bronze	Gold
1	Yang Zi Xuan	Temp	FuTian Shejian Association	2004	528	BYE	132	131		134
2	Song Yun	Temp	FuTian Shejian Association	2006	527	BYE	119	130		125
3	Song Yu Tai	Temp	FuTian Shejian Association	2007	345	91	112	100	123	
4	Zhang Xi He	Temp	FuTian Shejian Association	2006	370	BYE	102	113	94	
5	Li Zong Xi	Temp	FuTian Shejian Association	2005	447	BYE	105			
6	Huang Jun Yi	Temp	FuTian Shejian Association	2007	403	BYE	95			
7	Wu Si Long	Temp	FuTian Shejian Association	2006	262	94	89			
8	Zheng Su Tong	Temp	Liuzhou Archery Club	2007	303	91	65			
9	Wei De Long	Temp	FuTian Shejian Association	2006	251	70				
9	Fang Sheng Chuang	Temp	FuTian Shejian Association	2006	156	61				
9	Lin Yi Nuo	Temp	FuTian Shejian Association	2007	237	53				

Asian Youth Indoor Archery Open (Hong Kong 2016)(Star Shoot)

26-29 Jul 2016

Tin Shui Wai Sports Centre

Result Summary

Compound (Girl Division) Grade A

Rank	Name	Member No.	Team	YOB	QR Score	1/4	1/2	Bronze	Gold
1	Fatimah Al-Mashhdani	Temp	Iraqi Archery Federation	1998	542	BYE	139		142
2	Lam Claudia Wing Tung	M4012S	Hong Kong Fanling Lutheran Secondary School Archery Club (Hong Kong)	1997	569	BYE	138		138
3	Tang Lee Ka	M4114S	True Light Archery Club (Hong Kong)	1997	525	BYE	127	136	
4	Lau Tsz Sum	M4700S	Kwok Tak Seng Catholic Secondary School (Hong Kong)	1998	524	127	136	129	
5	Mui Wing Tung	M4685S	True Light Archery Club (Hong Kong)	1997	514	122			

Compound (Girl Division) Grade B

Rank	Name	Member No.	Team	YOB	QR Score	1/8	1/4	1/2	Bronze	Gold
1	Lau Tsz Ching	M4701S	Lock Tao Secondary School (Hong Kong)	2000	564	BYE	137	143		140
2	Fung Yee Lok	M5451S	STFA Seaward Woo College Archery Club (Hong Kong)	2001	538	BYE	134	133		136
3	Chong Wing Wa	M5447S	STFA Seaward Woo College Archery Club (Hong Kong)	2001	507	BYE	124	128	130	
4	Siu Wing Sang	M6004S	HKMA K. S. Lo College (Hong Kong)	2000	486	BYE	131	124	126	
5	Leung Ching Lam	M5733S	HK Youth Archery Squad (Hong Kong)	2001	498	BYE	130			
6	Leung Wing Sum	M5757S	True Light Archery Club (Hong Kong)	2001	541	BYE	130			
7	Lau Hoi Ching	M6048S	Hong Kong True Light College (Hong Kong)	2001	431	101	122			
8	Li Ka Yan	M5425S	Hong Kong Fanling Lutheran Secondary School (Hong Kong)	2001	519	BYE	115			
9	Yu Shuyi	M6052S	Hong Kong True Light College (Hong Kong)	2000	444	90				

Compound (Girl Division) Grade C

Rank	Name	Member No.	Team	YOB	QR Score	1/2	Bronze	Gold
1	Tung Ka Wai	M5745S	HKBUAS Wong Kam Fai Secondary and Primary School (Hong Kong)	2003	545	136		134
2	Zhang Rui Yu	Temp	FuTian Shejian Association	2002	510	122		124
3	Hui Ching Nam Crystal	M5764S	HK Youth Archery Squad (Hong Kong)	2002	521	122	130	
4	Lee Suet Wing	M6050S	Hong Kong True Light College (Hong Kong)	2002	500	129	122	